

B.U.S.F. - F.S.U.B.



**RÉSULTATS SAISON  
SPORTIVE 2023-2024  
UITSLAGEN**















Association Sportive de l'Enseignement  
Universitaire et Supérieur ASBL



## Fédération Sportive Universitaire Belge (FSUB)

2023-2024	Disciplines	Dates	Lieux 2023-24	Organisateurs 2023-24	Participants Enseignement Supérieur 2021-22	Participants Enseignement Supérieur 2022-23	Participants Enseignement Supérieur 2023-24	Institutions représentées 2021-22	Institutions représentées 2022-23	Institutions représentées 2023-24
	Athlétisme indoor	Ve 23/02/24	Topsportal Gent		510	525 (départs hors relais)	623 (départs hors relais)	34	35	38
	Athlétisme outdoor	Mer 01/05/24	Centre ADEPS "La Mosane" à Jambes		200 (départs hors relais)	362 (départs hors relais)	317 (départs hors relais)	27	35	29
	Badminton	Mer 13/12/23	Sportal UAntwerpen Stadscampus		38 + 16 équipes en double	82 + 20 équipes en double	62	9	13	13
	Course d'Oriente (Forêt)	Di 25/02/24	Tihange		31	31	22	6	7	7
	Course d'Oriente (Urbaine)	Ma 30/04/24	Park Spoor Noord à Antwerpen		/	15	15	/	4	4
	Cross-Country	Sa 11/11/24	Parc Allard - Braine L'Alleud (club USBW)		155	156	133	17	17	22
	Cyclisme Hommes	Ma 25/06/24	Café Casa Nostra à Zomergem		22	29 (1 francophone)		9	9	
	Cyclisme Dames	Me 24/04/24	Parochiaal Centrum à Herne		28 (1 francophone)	25 (2 francophones)	19 (0 francophone)	14	13	8
	Echecs	Je 14/03/24	Odisee technologiecampus (Campus Brussel)		59	63	30	18	14	10
	Echecs (online)	Ma 17/10/23	Sur la plateforme <a href="http://www.lichess.org">http://www.lichess.org</a>		/	/	63	/	/	16
	Escalade	Sa 02/03/24	Sale d'escalade "The Island" Antwerpen		/	27	45	/	5	10
	Escrime	Sa 10/02/24	Club des 3 armes - Gembloux		79	57	59	21	19	17
	Floorball	Mer 21/02/24	Lago Rozenbroeken- <b>ANNULE</b>		3 (8 joueurs/équipes)	/	/	3	/	/
	Frisbee (Ultimate)	Mer 27/03/24	Sport Centrum KU Leuven (Arenberg)		/	/	3 équipes (10 joueurs/équipes)	/	/	3
	Gymnastique	Lu 18/03/24	Blocry à Louvain-la-Neuve		41	58	66	7	10	10
	Judo individuel	Mer 13/12/23	Université de Mons		78	71	61	21	19	21

## Fédération Sportive Universitaire Belge (FSUB)

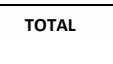
2024	Disciplines	Dates	Lieux 2023-24	Organisateurs 2023-24	Participants Enseignement Supérieur 2021-22	Participants Enseignement Supérieur 2022-23	Participants Enseignement Supérieur 2023-24	Institutions représentées 2021-22	Institutions représentées 2022-23	Institutions représentées 2023-24
	Judo par équipe	Mer 13/03/24	Université de Mons		6 équipes (12 joueurs/équipes)	7 équipes (12 joueurs/équipes)	6 équipes (12 joueurs/équipes)	5	7	5
	Natation	Ma 16/04/24	Piscine de Groenenhoek (Antwerpen)		108 (départs hors relais)	198 (départs hors relais)	252 (départs hors relais)	16	13	17
	Padel	Mer 29/11/23 (qualifs) Ma 23/04/24 (finales)	Sport Centrum KU Leuven (Arenberg)		5 équipes (double)	8 équipes (double)	22 équipes (double)	5	3	8
	Rugby VII- Chpt	Je 26/10/23	Kituro Rugby Club - Schaerbeek		4 équipes hommes 3 équipes dames	/	7 équipes hommes 5 équipes dames	4 (hommes) 4 (dames)	/	6 (hommes) 5 (dames)
	Rugby VII- Tournoi	Pas programmé	Kituro Rugby Club - Schaerbeek		6 équipes hommes 3 équipes dames	/	/	6 (hommes) 3 (dames)	/	/
	Tennis de Table	Sa 28/10/23	Salle Omnisport de Cuesmes	 	34	70	63	12	15	18
	1/4 Triathlon	Di 26/05/24	Seneffe (club des Titans)		17	30	38	11	11	15
<b>TOTAL</b>					<b>1698</b>	<b>1308</b>	<b>2134</b>			

# Resultaten BSK indoor atletiek

## Topsporthal Vlaanderen

### Vrijdag 23 februari 2024





## 60 m heren

Plaats	Voornaam	Naam	Geslacht	Onderwijsinstelling	Resultaat
1	Adrien	Devriendt	m	Hogeschool MVES	6,85
2	Niels	Kerkhofs	m	Universiteit Hasselt	6,9
3	Jaron	De Vriese	m	Katholieke Universiteit Leuven	6,96
4	Yoran	Deschepper	m	Hogeschool MVES	6,97
5	Cédric	Verschuere	m	Universiteit Gent	6,97
6	Iben	Degryse	m	Katholieke Universiteit Leuven	7,02
7	Jitse	Mievis	m	Erasmus Hogeschool Brussel	7,05
8	Siemen	Masure	m	Universiteit Gent	7,06
9	Floran	Dehout	m	HE Louvain en Hainaut	7,08
10	Sidy	Gueye	m	Vrije Universiteit Brussel	7,08
11	Tibe	Temmerman	m	Universiteit Gent	7,08
12	Thomas	Van Herreweghe	m	Odisee Hogeschool	7,09
13	Wolf	Beliën	m	Hogeschool Gent	7,1
14	Jasper	Annys	m	Hogeschool MVES	7,11
15	Maxime	Debacker	m	HE Louvain en Hainaut	7,12
16	Florian	Farese	m	Ecole Pratiques des Hautes Études Commerciales	7,13
17	Enguerran	Bossicard	m	HE Louvain en Hainaut	7,15
18	Arthur	Bouchat	m	Université Catholique de Louvain	7,15
19	Zola	Tchoubou	m	HE Libre de Bruxelles	7,15
20	Cobe	Plasschaert	m	Hogeschool MVES	7,15
21	Zaaquib Yunus	Ahmed	m	Universiteit Gent	7,16
22	Hadrien	Piengeon	m	Université Catholique de Louvain	7,19
23	Reginald	Beele	m	ICHEC-ECAM-ISFSC	7,19
24	Jonathan	Claes	m	Katholieke Universiteit Leuven	7,19
25	Quinten	Jochems	m	Katholieke Universiteit Leuven	7,19
26	Marko	Medan	m	Université Libre de Bruxelles	7,22
27	Nils	Romswinkel	m	Universiteit Gent	7,22
28	Corentin	Annet	m	Université Catholique de Louvain	7,23
29	Dai	Kéata	m	Katholieke Universiteit Leuven	7,24
30	Timo	De Grande	m	Hogeschool UC Leuven	7,26
31	Viktor	Van Aerde	m	Hogeschool Gent	7,26
32	Jamie-Jake	Allotey	m	Universiteit Gent	7,26
33	Michael	Yerasimou	m	Université Catholique de Louvain	7,26
34	Enzo	Mayuma	m	HE Louvain en Hainaut	7,26
35	Frederik	Claes	m	Universiteit Hasselt	7,26
36	Mateo	Loforte	m	HE Libre Mosane	7,27
37	Olivier	Uwamungu-Ngira	m	Katholieke Universiteit Leuven	7,28
38	Théo	Rositano	m	HE Louvain en Hainaut	7,28
39	Wilfried	Adodo	m	Université Libre de Bruxelles	7,3
40	Arnaud	Klein	m	Université Libre de Bruxelles	7,3
41	Loïc	Mijle	m	Université Catholique de Louvain	7,31
42	Jasper	Vermaelen	m	Hogeschool UC Leuven	7,32
43	Tim	Depickere	m	Katholieke Universiteit Leuven	7,33
44	Guillaume	Dominic	m	Université Catholique de Louvain -St Louis	7,34
45	Jasper	Van Den Bulcke	m	Universiteit Gent	7,35
46	Siebe	Hauttekeete	m	Universiteit Gent	7,35
47	Komi Daniel	Anani	m	Erasmus Hogeschool Brussel	7,36
48	Lucas	Vercaeren	m	Karel de Grote Hogeschool	7,39
49	Lorin	Speybrouck	m	Universiteit Gent	7,42
50	Noël	Koch	m	Université Catholique de Louvain	7,45
51	Alexander	Van Vliet	m	Universiteit Gent	7,45
52	Jelle	van der Deure	m	Katholieke Universiteit Leuven	7,46
53	Renzo	Van de Vyvere	m	Universiteit Gent	7,48
54	Victor	Suy	m	Universiteit Gent	7,5
55	Jonathan	Vanden Eynden Van Lysebeth	m	Vrije Universiteit Brussel	7,51
56	Sverre	Ramakers	m	Universiteit Gent	7,51
57	Gilles	Cimino	m	HE Léonard de Vinci	7,52
58	Ali	Lachkar	m	Université Libre de Bruxelles	7,54
59	Mathis	Vandenbussche	m	Universiteit Gent	7,54
60	Pieter	Spaey	m	Universiteit Gent	7,57

61	ThÃ©odore	Scheere	m	UniversitÃ© Libre de Bruxelles	7,59
62	RenÃ©	Clinckspoor	m	Hogeschool Gent	7,59
63	Tristan	Bistrussu	m	Hogeschool UC Limburg	7,6
64	Corneel	De Reys	m	Universiteit Antwerpen	7,6
65	IsmaÃ©l	DiamÃ©	m	HELiÃ©onard de Vinci	7,63
66	Romain	Dumortier	m	UniversitÃ© de LiÃ©ge (site de LiÃ©ge)	7,64
67	Lode	Van de Vreken	m	Universiteit Gent	7,64
68	Yarne	Ukens	m	Hogeschool UC Limburg	7,66
69	Noa	Provoost	m	UniversitÃ© de LiÃ©ge (site de LiÃ©ge)	7,68
70	Rodan	NoÃ©	m	Universiteit Gent	7,68
71	Yente	Van den Broeck	m	Universiteit Gent	7,68
72	Lukas	Vanuytrecht	m	HELiÃ©onard de Vinci	7,69
73	Jurgen	Mambre	m	Arteveldehogeschool	7,69
74	OnÃ©sime	Kiakonda	m	HELiÃ©onard de Vinci	7,71
75	Armand	Okundji	m	Katholieke Universiteit Leuven	7,71
76	Henri	Vande Cavey	m	Odisee Hogeschool	7,72
77	Thibaut	Dhooge	m	Karel de Grote Hogeschool	7,72
78	Jarne	Buyse	m	Hogeschool VMES	7,73
79	Otis	Van Kerm	m	UniversitÃ© Catholique de Louvain	7,75
80	Mathis	Vandesmal	m	Ecole Royale Militaire	7,76
81	Sacha	Mansour	m	UniversitÃ© Libre de Bruxelles	7,78
82	Jacob	Keppens	m	Katholieke Universiteit Leuven	7,78
83	Ridwan	Hadj Faraji	m	UniversitÃ© Libre de Bruxelles	7,8
84	Valentijn	Braeckman	m	LUCA, school of arts	7,81
85	Alexis	Van ElsuwÃ©	m	UniversitÃ© Libre de Bruxelles	7,89
86	Tibo	De Schepper	m	Universiteit Gent	7,89
87	Amin	Kitmir	m	UniversitÃ© Libre de Bruxelles	7,91
88	Lois	Dejasse	m	UniversitÃ© Catholique de Louvain	7,99
89	Bilal	Hammane	m	Hogeschool West-Vlaanderen	7,99
90	Antoine	Pisetta	m	UniversitÃ© Catholique de Louvain	8,05
91	Jesse	Brant	m	Katholieke Universiteit Leuven	8,05
92	Ethan SÃ©bastien	Dumont	m	HE Provinciale du Hainaut-Condorcet	8,09
93	AurÃ©lien	Belle	m	HELouvain en Hainaut	8,14
94	Pierre	Hauseux	m	HE de la Province de LiÃ©ge	8,19
95	Jean-Claude	Charlier	m	UniversitÃ© Catholique de Louvain	8,21
96	Victor	Recour	m	Hogeschool West-Vlaanderen	8,45
97	MichaÃ©l	De Prins	m	Karel de Grote Hogeschool	8,6

## 60m Dames

Plaats	Voornaam	Naam	Geslacht	Onderwijsinstelling	Resultaat
1	Rani	Vincke	v	Universiteit Gent	7,36
2	Janie	De Naeyer	v	Universiteit Antwerpen	7,46
3	Lotte	Van Lent	v	Katholieke Universiteit Leuven	7,47
4	Manon	Depuydt	v	Universiteit Gent	7,52
5	Laures	Bauwens	v	Universiteit Gent	7,57
6	Nora	Thiry	v	HE de la Province de Liège	7,64
7	Noor	Koekelkoren	v	Arteveldehogeschool	7,64
8	Angel	Agwazie	v	Odisee Hogeschool	7,65
9	Noor	Vermeiren	v	Artesis Plantijn Hogeschool Antwerpen	7,78
10	Fleur	Hooyberghs	v	Universiteit Gent	7,79
11	Emma	Broze	v	HE Léonard de Vinci	7,79
12	Caroline	Vanhamme	v	Université Catholique de Louvain	7,84
13	Lore	Boonen	v	Katholieke Universiteit Leuven	7,85
14	Kyra	Janssens	v	Vrije Universiteit Brussel	7,88
15	Catherine	De Bie	v	Katholieke Universiteit Leuven	7,9
16	Nina	Denolf	v	Universiteit Gent	7,91
17	Ornelia	Nyanit	v	Université Catholique de Louvain	7,93
18	Christelle	Nsiala Kapinga Katanga	v	Université Catholique de Louvain	7,96
19	Jenna	De Smet	v	Universiteit Gent	7,97
20	Hanna	Vereecke	v	Vrije Universiteit Brussel	7,97
21	Nona	Heyvaert	v	Arteveldehogeschool	7,97
22	Luca	Heyvaert	v	Odisee Hogeschool	8,01
23	Chloé	O'Shea	v	Université Catholique de Louvain	8,01
24	Emeline	Cleymans	v	Université Catholique de Louvain	8,01
25	Caro	Vander Avert	v	Karel de Grote Hogeschool	8,01
26	Aline	Bosquet	v	Université Libre de Bruxelles	8,02
27	Valentine	Anyanwu	v	Hogeschool UC Leuven	8,06
28	May Lee	Cooper	v	Université de Liège (site de Gembloux)	8,07
29	Kato	De Schepper	v	Universiteit Gent	8,13
30	Noa	Buis	v	Université de Liège (site de Liège)	8,13
31	Yana	Goosen	v	Universiteit Gent	8,13
32	Axelle	Praet	v	Universiteit Gent	8,16
33	Ella	Heyvaert	v	Vrije Universiteit Brussel	8,19
34	Elea	Godeau	v	Université Libre de Bruxelles	8,21
35	Caroline	Bloch	v	HE de la Province de Liège	8,22
36	Erja	Jerouville	v	Université Catholique de Louvain	8,22
37	Lore	Van den Bremt	v	Hogeschool West-Vlaanderen	8,23
38	Libelia	Vincke	v	Hogeschool West-Vlaanderen	8,26
39	Clémence	Huybens	v	Université Catholique de Louvain	8,26
40	Valentine	Frans	v	Université de Liège (site de Liège)	8,27
41	Jutta	Hutsebaut	v	Katholieke Universiteit Leuven	8,32
42	Lisa	De Troyer	v	Hogeschool Gent	8,33
43	Frea	Deroost	v	Katholieke Universiteit Leuven	8,33
44	Lotte	Van Masselaer	v	Katholieke Universiteit Leuven	8,33
45	Louise	Thierens	v	Universiteit Gent	8,34
46	Karlien	Eelen	v	Universiteit Antwerpen	8,35
47	Valentine	Ronveaux	v	HE Louvain en Hainaut	8,38
48	Léa	Pinter	v	Université Catholique de Louvain	8,39
49	Iryna	Bombo	v	Université Libre de Bruxelles	8,4
50	Nele	Vermeulen	v	Hogeschool West-Vlaanderen	8,4
51	Svelte	Mariën	v	Katholieke Universiteit Leuven	8,42
52	Emma	Frans	v	HE Libre Mosane	8,43
53	Lisa	Van Renterghem	v	Hogeschool Gent	8,48
54	Adeline	Brunin	v	Université Catholique de Louvain	8,48
55	Miek	Lagaeyse	v	Universiteit Gent	8,54
56	Amelie	Buyck	v	Arteveldehogeschool	8,56
57	Anne-Ramon	Cole	v	Vrije Universiteit Brussel	8,64

58	Eline	Van Doorslaer	v	Universiteit Gent	8,66
59	Emma	Lengel	v	Universit� Catholique de Louvain	8,66
60	Eline	De Muynck	v	Hogeschool Gent	8,72
61	Ellen	Seghers	v	Thomas More	8,75
62	Fleur	Deschaux	v	HELAConard de Vinci	8,75
63	Hannah	Logier	v	Universiteit Gent	8,89
64	Margot	Mortamet	v	Universit� Catholique de Louvain	8,95
65	Eline	Demeester	v	Universiteit Gent	9,06
66	Fien	Van den Bremt	v	Universiteit Gent	9,16
67	Saar	Van hoof	v	Universiteit Gent	9,18
68	Lucie	Martin	v	Universit� Catholique de Louvain	9,2
69	Laura	Van Aelten	v	Katholieke Universiteit Leuven	9,21
70	Ellen	Janssens	v	Universiteit Gent	9,26
71	Chlo�	Bulteau	v	HEBruxelles - Brabant	9,31
72	Ma�th�	Merchie	v	Universiteit Gent	9,4
73	Jessie	Duquesne	v	Universiteit Gent	9,49
74	Lynn	Beck	v	Katholieke Universiteit Leuven	DNS
75	Emma	De Naeyer	v	Universiteit Gent	DNS
76	Sara	Van Hoyweghen	v	Universiteit Gent	DQ

## 200m heren

Plaats	Voornaam	Naam	Geslacht	Onderwijsinstelling	Resultaat
1	Adrien	Devriendt	m	Hogeschool VIVES	21,15
2	Cobe	Plasschaert	m	Hogeschool VIVES	21,77
3	Floran	Dehout	m	HE Louvain en Hainaut	21,79
4	Hadrien	Piengeon	m	Universit�� Catholique de Louvain	22,16
5	Jitse	Mievis	m	Erasmus Hogeschool Brussel	22,46
6	Tuur	Bras	m	Vrije Universiteit Brussel	22,53
7	Frederik	Claes	m	Universiteit Hasselt	22,56
8	Sidy	Gueye	m	Vrije Universiteit Brussel	22,58
9	Tibe	Temmerman	m	Universiteit Gent	22,67
10	Jasper	Van Den Bulcke	m	Universiteit Gent	22,7
11	J��rme	Diddens	m	Hogeschool Gent	22,87
12	Marko	Medan	m	Universit�� Libre de Bruxelles	22,94
13	Olivier	Uwamungu-Ngira	m	Katholieke Universiteit Leuven	22,97
14	Jamie-Jake	Allotey	m	Universiteit Gent	23,07
15	Corentin	Annet	m	Universit�� Catholique de Louvain	23,08
16	Florian	Farese	m	Ecole Pratiques des Hautes ��tudes Commer	23,09
17	Ilias	Thienpondt	m	Odisee Hogeschool	23,2
18	Yente	Van den Broeck	m	Universiteit Gent	23,3
19	Lucas	Vercaeren	m	Karel de Grote Hogeschool	23,31
20	X��nder	Beyers	m	Thomas More	23,31
21	Jasper	Vermaelen	m	Hogeschool UC Leuven	23,42
22	Romain	Dumortier	m	Universit�� de Li��ge (site de Li��ge)	23,45
23	Timo	De Grande	m	Hogeschool UC Leuven	23,46
24	Driss	Vergels	m	Katholieke Universiteit Leuven	23,46
25	Mateo	Loforte	m	HE Libre Mosane	23,47
26	Jonathan	Claes	m	Katholieke Universiteit Leuven	23,5
27	Gilles	Cimino	m	HE Li��onard de Vinci	23,5
28	Lorin	Speybrouck	m	Universiteit Gent	23,58
29	Tibo	Convens	m	Katholieke Universiteit Leuven	23,64
30	Emiel	Dieussaert	m	Universiteit Gent	23,65
31	Jonathan	Vanden Eynden Van Lysebeth	m	Vrije Universiteit Brussel	23,7
32	Nicolas	Scarniet	m	Universit�� Catholique de Louvain	23,71
33	Ali	Lachkar	m	Universit�� Libre de Bruxelles	23,85
34	Wilfried	Adodo	m	Universit�� Libre de Bruxelles	23,86
35	Arnaud	Klein	m	Universit�� Libre de Bruxelles	23,99
36	Guillaume	Domin��	m	Universit�� Catholique de Louvain -St Louis	23,99
37	Sverre	Ramakers	m	Universiteit Gent	24,25
38	Th��odore	Scheere	m	Universit�� Libre de Bruxelles	24,34
39	Mathis	Vandenbussche	m	Universiteit Gent	24,38
40	Corneel	De Reys	m	Universiteit Antwerpen	24,43
41	Mathis	Vandesmal	m	Ecole Royale Militaire	24,43
42	Sacha	Mansour	m	Universit�� Libre de Bruxelles	24,54
43	Jame	Buyse	m	Hogeschool VIVES	24,56
44	Y��rne	Ulens	m	Hogeschool UC Limburg	24,58
45	X��nder	Springael	m	Katholieke Universiteit Leuven	24,66
46	Victor	Suy	m	Universiteit Gent	24,69
47	Rodan	No��l	m	Universiteit Gent	24,84
48	Lois	Dejasse	m	Universit�� Catholique de Louvain	25,01
49	Tom	De Tollenaere	m	HE Li��onard de Vinci	25,28
50	Armand	Okundji	m	Katholieke Universiteit Leuven	25,39
51	Thibaut	Dhooge	m	Karel de Grote Hogeschool	25,43

52	Axel	Ringoot	m	Universiteit Gent	25,43
53	Abdssamad	Hguiggach	m	Universit� Catholique de Louvain	25,53
54	Tristan	Bistrussu	m	Hogeschool UC Limburg	25,78
55	Bilal	Hammane	m	Hogeschool West-Maanderen	26,18
56	Elias	Rom	m	Thomas More	26,33
57	Jean-Claude	Charlier	m	Universit� Catholique de Louvain	26,4
58	Stan	Devriendt	m	Hogeschool VIVES	26,87
59	Ethan S�bastien	Dumont	m	HE Provinciale du Hainaut-Condorcet	27,18
60	Pierre	Hauseux	m	HE de la Province de Li�ge	27,19
61	Aur�lien	Belle	m	HE Louvain en Hainaut	27,2
62	Louis	Lucion	m	Universit� Catholique de Louvain	27,28
63	Aurelien	Turneer	m	HE L�onard de Vinci	27,72
64	Victor	Recour	m	Hogeschool West-Maanderen	28,3
65	Micha�d	De Prins	m	Karel de Grote Hogeschool	29,55
66	Siemen	Masure	m	Universiteit Gent	DNS
67	Komi Daniel	Anani	m	Erasmus Hogeschool Brussel	DNS
68	Noa	Provoost	m	Universit� de Li�ge (site de Li�ge)	DNS
69	Zaaquib Yunus	Ahmed	m	Universiteit Gent	DQ
70	Michael	Yerasimou	m	Universit� Catholique de Louvain	DQ
71	No�	Koch	m	Universit� Catholique de Louvain	DQ
72	Jonas	Van Damme	m	Universiteit Gent	DQ

## 200 m Dames

Plaats	Voornaam	Naam	Geslacht	Onderwijsinstelling	Resultaat
1	Janie	De Naeyer	v	Universiteit Antwerpen	23,99
2	Rani	Vincke	v	Universiteit Gent	24,26
3	Noor	Vermeiren	v	Artesis Plantijn Hogeschool Antwerpen	24,64
4	Emma	Verhulst	v	Thomas More	24,72
5	Emma	Broze	v	HE LiÃ©onard de Vinci	24,88
6	Nora	Thiry	v	HE de la Province de LiÃ©ge	24,89
7	Anouchka	Kadiamba	v	Hogeschool Gent	24,99
8	Jenna	De Smet	v	Universiteit Gent	25,05
9	Hanna	Vereecke	v	Vrije Universiteit Brussel	25,18
10	Caroline	Vanhamme	v	UniversitÃ© Catholique de Louvain	25,24
11	Nina	Denolf	v	Universiteit Gent	25,35
12	ZoÃ©	Laureys	v	Universiteit Gent	25,5
13	Nona	Heyvaert	v	Arteveldehogeschool	25,65
14	Justine	Praet	v	Universiteit Gent	25,85
15	Laura	Van den Brande	v	Universiteit Gent	25,85
16	ElÃ©a	Latinne	v	HE LiÃ©onard de Vinci	25,91
17	May Lee	Cooper	v	UniversitÃ© de LiÃ©ge (site de Gembloux)	25,96
18	Caro	Vander Avert	v	Karel de Grote Hogeschool	26,01
19	ThaÃ©s	Favoreel	v	Universiteit Gent	26,05
20	Clara	De Vare	v	Katholieke Universiteit Leuven	26,05
21	Amelie	Sonneville	v	Universiteit Gent	26,12
22	Claire	Jacobs	v	Katholieke Universiteit Leuven	26,22
23	Evi	De Baets	v	Universiteit Gent	26,25
24	Emeline	Cleymans	v	UniversitÃ© Catholique de Louvain	26,35
25	Elea	Godeau	v	UniversitÃ© Libre de Bruxelles	26,36
26	Aline	Bosquet	v	UniversitÃ© Libre de Bruxelles	26,39
27	OrnÃ©lia	Nyanit	v	UniversitÃ© Catholique de Louvain	26,52
28	Valentine	Frans	v	UniversitÃ© de LiÃ©ge (site de LiÃ©ge)	26,85
29	Lore	Van den Bremt	v	Hogeschool West-Maanderen	26,9
30	ZÃ©lie	Boucquey	v	UniversitÃ© Catholique de Louvain	26,95
31	Zoe	DevillÃ©	v	Hogeschool PXL	27
32	Caro	Hellinckx	v	Universiteit Gent	27,05
33	Amber	Boutens	v	Universiteit Gent	27,06
34	Iryna	Bombo	v	UniversitÃ© Libre de Bruxelles	27,15
35	Lotte	Van der Vreken	v	Universiteit Gent	27,17
36	Ella	Heyvaert	v	Vrije Universiteit Brussel	27,19
37	Karliën	Eelen	v	Universiteit Antwerpen	27,3
38	Yana	Goosen	v	Universiteit Gent	27,36
39	Nele	Vermeulen	v	Hogeschool West-Maanderen	27,37
40	Adeline	Brunin	v	UniversitÃ© Catholique de Louvain	27,61
41	Amelie	Buyck	v	Arteveldehogeschool	27,72
42	Beryl	Owusu	v	Hogeschool Gent	27,76
43	Emma	Frans	v	HE Libre Mosane	27,98
44	Camille	Chauvin	v	HE Provinciale du Hainaut-Condorcet	28,02
45	Louise	Thierens	v	Universiteit Gent	28,43
46	Marie-Jo	Desplenter	v	Hogeschool VIVES	28,49
47	Antje	De Schryver	v	Hogeschool Gent	28,7
48	Eline	Van Doorslaer	v	Universiteit Gent	28,72
49	Eline	De Mynck	v	Hogeschool Gent	28,81
50	Miek	Lagaeyse	v	Universiteit Gent	29,27
51	Margot	Mortamet	v	UniversitÃ© Catholique de Louvain	29,59

52 Alessia	Mossuto	v	HE Bruxelles - Brabant	29,75
53 Hannah	Logier	v	Universiteit Gent	30,04
54 Nathalie	Huynh	v	Universit� Catholique de Louvain	30,47
55 Evelyne	Huyghe	v	Katholieke Universiteit Leuven	30,61
56 Ellen	Janssens	v	Universiteit Gent	30,7
57 Saar	Van hoof	v	Universiteit Gent	30,82
58 Chlo�	Bulteau	v	HE Bruxelles - Brabant	30,84
59 Ma� th�	Merchie	v	Universiteit Gent	31,26
60 Laura	Van Aelten	v	Katholieke Universiteit Leuven	31,36
61 Jessie	Duquesne	v	Universiteit Gent	33,53
62 Kato	De Schepper	v	Universiteit Gent	DNS
63 Ellen	Seghers	v	Thomas More	DNS
64 Mait�	Beernaert	v	Katholieke Universiteit Leuven	DNS
65 Leonie	Van Vynckt	v	Universiteit Gent	DNS
66 Anne-Ramon	Cole	v	Vrije Universiteit Brussel	DQ
67 Yelena	Boone	v	Universiteit Gent	DQ



## 400m Heren

Plaats	Voornaam	Naam	Geslacht	Onderwijsinstelling	Resultaat
1	Axel	Ringoot	m	Universiteit Gent	01:00,2
2	Jonathan	Sacoor	m	Vrije Universiteit Brussel	47,05
3	Daniel	Segers	m	Universiteit Gent	47,27
4	Killian	Mersseman	m	Arteveldehogeschool	48,56
5	Maarten	Heylen	m	Katholieke Universiteit Leuven	48,84
6	Tibo	Malumgrat	m	Universiteit Gent	49,26
7	Tijs	Bruyns	m	Katholieke Universiteit Leuven	49,44
8	Nils	Romswinkel	m	Universiteit Gent	50,11
9	Milan	Van de Walle	m	Katholieke Universiteit Leuven	51,07
10	Pierre	Malkic	m	Université Libre de Bruxelles	51,73
11	Jelle	van der Deure	m	Katholieke Universiteit Leuven	51,94
12	Wout	Van Hoof	m	Universiteit Gent	52,22
13	Justin	Toussaint	m	HE de Namur Liège Luxembourg	52,49
14	Yente	Michiels	m	Universiteit Gent	53,23
15	Jonas	Huyck	m	Katholieke Universiteit Leuven	53,42
16	Souhaïb	Azzouz	m	Université Catholique de Louvain	54,62
17	Thibaut	Delvin	m	HE Libre de Bruxelles	54,69
18	Ebert	Vermeersch	m	Hogeschool VIVES	54,92
19	Yanis	Ferrieres Bernard	m	HE Léonard de Vinci	55
20	Sacha	Mansour	m	Université Libre de Bruxelles	55,6
21	Kvinten	Breugelmans	m	Katholieke Universiteit Leuven	55,9
22	Chao-Yuan	Liu	m	Katholieke Universiteit Leuven	56,06
23	Louis	Hillen	m	Katholieke Universiteit Leuven	56,33
24	Otis	Van Kerm	m	Université Catholique de Louvain	57,16
25	Mathieu	Deneyer	m	Hogeschool VIVES	58,08
26	Maarten	Vermaelen	m	Vrije Universiteit Brussel	58,16
27	Arne	Dawyndt	m	Hogeschool West-Vlaanderen	DNF
28	Ismaël	Diamant	m	HE Léonard de Vinci	DNS
29	Mathys	Latinne	m	Université Catholique de Louvain	DNS

## 400m Dames

Plaats	Voornaam	Naam	Geslacht	Onderwijsinstelling	Resultaat
1	Timea	Huyck	v	Universiteit Gent	01:00,8
2	Michelle	Debal	v	Hogeschool VIVES	01:01,2
3	Ina	Schepers	v	Universiteit Hasselt	01:01,4
4	Loike	Vierendeels	v	Universiteit Gent	01:01,5
5	Stien	Van Loock	v	Katholieke Universiteit Leuven	01:01,9
6	Lara	Arefi	v	Universiteit Gent	01:02,0
7	LÃ©a	Scutnaire	v	HE Provinciale du Hainaut-Condorcet	01:02,2
8	Morgan	Laporte	v	Katholieke Universiteit Leuven	01:02,4
9	Lotte	Stuer	v	Universiteit Hasselt	01:02,5
10	Eveline	Ex	v	Katholieke Universiteit Leuven	01:03,1
11	Jana	Milutinovic	v	Katholieke Universiteit Leuven	01:03,2
12	Lisa	Libberecht	v	Katholieke Universiteit Leuven	01:03,6
13	Olive	Awouters	v	Hogeschool UC Leuven	01:04,3
14	Hanne	Thiel	v	Universiteit Gent	01:05,1
15	Lemoni	Claeys Heymans	v	Universiteit Gent	01:06,2
16	Liefde	Schoemaker	v	UniversitÃ© Libre de Bruxelles	55,4
17	Eline	Claeys	v	Universiteit Gent	55,43
18	CloÃ©	Van der Meulen	v	Universiteit Gent	55,79
19	Hanne	Maudens	v	Universiteit Gent	57,32
20	Jitse	Steenmans	v	Katholieke Universiteit Leuven	58,05
21	Lore	Van der Gaast	v	Katholieke Universiteit Leuven	58,77
22	Charline	Lefevre	v	UniversitÃ© de LiÃ©ge (site de LiÃ©ge)	59,39
23	Nore	Vandekerckhove	v	Arteveldehogeschool	59,99
24	ChloÃ©	Scheirlinckx	v	UniversitÃ© Catholique de Louvain	DNS

## 800m heren

Plaats	Voornaam	Naam	Geslacht	Onderwijsinstelling	Resultaat
1	Timon	Inghelbrecht	m	Katholieke Universiteit Leuven	01:50,9
2	Mathis	Espagnet	m	HE de la Province de Liège	01:51,3
3	Maxime	Delvoie	m	Université Catholique de Louvain	01:51,6
4	Joachim	Bafort	m	Universiteit Gent	01:53,5
5	Louis	Carmans	m	Katholieke Universiteit Leuven	01:53,7
6	Dieter	Vaesen	m	Hogeschool PXL	01:55,2
7	Thimon	Van Herrewege	m	Hogeschool Gent	01:56,4
8	Dries	Peeters	m	Katholieke Universiteit Leuven	01:56,7
9	Justin	Toussaint	m	HE de Namur Liège Luxembourg	01:57,1
10	Carlos	Jiménez Andrino	m	Hogeschool VIVES	01:59,5
11	Jan	Gobert	m	Universiteit Antwerpen	01:59,8
12	Tom	Duysinx	m	Université de Liège (site de Liège)	01:59,9
13	Warre	Bouckaert	m	Universiteit Gent	02:02,0
14	Ferre	Vandeuren	m	Vrije Universiteit Brussel	02:02,8
15	Storm	Vervloet	m	Thomas More	02:03,2
16	Cyril	Jurion	m	Université de Liège (site de Liège)	02:03,3
17	Koh	Ikuchi	m	Katholieke Universiteit Leuven	02:03,9
18	Greg	Wenshell	m	Katholieke Universiteit Leuven	02:03,9
19	Ilian	Van der Meiren	m	Universiteit Gent	02:03,9
20	Corentin	Beyaert	m	Vrije Universiteit Brussel	02:05,3
21	Robbe	Putzeys	m	Universiteit Hasselt	02:05,5
22	Arnaud	Masschaele	m	HE de Namur Liège Luxembourg	02:06,6
23	François	Brandt	m	Université Catholique de Louvain	02:07,6
24	Théo	Herbay	m	Université Catholique de Louvain	02:08,2
25	Tim	Vandevelde	m	Universiteit Gent	02:09,2
26	Lucas	Bastin	m	HE de Namur Liège Luxembourg	02:09,5
27	Louis	Pecheur	m	Université Catholique de Louvain	02:11,6
28	Renaud	Van Hees	m	Université Catholique de Louvain	02:12,4
29	Mágiel	Vermeiren	m	Universiteit Gent	02:12,8
30	Mathieu	Deneyer	m	Hogeschool VIVES	02:13,5
31	Florent	Albert	m	Université Catholique de Louvain	02:22,0
32	Jolan	Heyse	m	Universiteit Gent	02:29,7
33	André	Goffart	m	HE Libre Mosane	02:36,9
34	Aurele	Vandeputte	m	Universiteit Gent	DNF

## 800m Dames

Plaats	Voornaam	Naam	Geslacht	Onderwijsinstelling	Resultaat
1	Vanessa	Scaunet	v	Erasmus Hogeschool Brussel	02:08,6
2	Nel	Vanopstal	v	Katholieke Universiteit Leuven	02:09,0
3	Laure	Bilo	v	Universiteit Gent	02:09,7
4	Emma	D'haene	v	Hogeschool Gent	02:15,9
5	Clarisse	Bonin	v	HE LiÃ©onard de Vinci	02:16,1
6	Lotte	Willems	v	Odisee Hogeschool	02:22,7
7	Josephine	De Brouwer	v	Vrije Universiteit Brussel	02:22,8
8	Sofie	SerrÃ©	v	Hogeschool UC Leuven	02:23,3
9	Lucie	Lechat	v	UniversitÃ© Catholique de Louvain	02:24,2
10	CÃ©lia	Ponlot	v	UniversitÃ© de LiÃ©ge (site de LiÃ©ge)	02:24,7
11	Sarah	Lallemand	v	UniversitÃ© Catholique de Louvain	02:26,0
12	AmÃ©lie	Paulart	v	HE Louvain en Hainaut	02:26,1
13	Emma	De Keyser	v	Universiteit Antwerpen	02:26,1
14	Eva	Melin	v	UniversitÃ© de LiÃ©ge (site de LiÃ©ge)	02:26,3
15	Aude	Vandenputte	v	LUCA, school of arts	02:29,4
16	Jente	Van Droogenbroeck	v	Arteveldehogeschool	02:31,8
17	Joke	Cuyt	v	Universiteit Gent	02:34,3
18	Saar	Vermijs	v	Universiteit Gent	02:34,4
19	Olga	de Vinck	v	UniversitÃ© Catholique de Louvain	02:57,9
20	NoÃ©mie	Fernandes	v	HE Louvain en Hainaut	03:03,0

## 1500m Heren

Plaats	Voornaam	Naam	Geslacht	Onderwijsinstelling	Resultaat
1	Viktor	Leenaert	m	Universiteit Gent	04:02,0
2	Aaron	Van Lersberghe	m	Katholieke Universiteit Leuven	04:03,6
3	Andy	Keymolen	m	Vrije Universiteit Brussel	04:03,9
4	Quentin	Janton	m	Universit� Catholique de Louvain	04:04,4
5	Brent	Soetens	m	Universiteit Gent	04:07,9
6	Martin	Oldenhove	m	Universit� Catholique de Louvain	04:07,9
7	Hugo	Bossier	m	Vrije Universiteit Brussel	04:08,2
8	Wout	Logier	m	Hogeschool VIVES	04:08,3
9	Lo�c	Delvaux	m	HE Charlemagne	04:09,6
10	Guillaume	Paulissen	m	Universit� de Namur	04:10,0
11	Thibault	Leli�vre	m	Universit� Catholique de Louvain	04:10,2
12	Victor	Mullens	m	Universit� Catholique de Louvain	04:10,6
13	Rob	Van den Bogaert	m	Hogeschool Gent	04:10,8
14	Siebe	Van Campenhout	m	Vrije Universiteit Brussel	04:11,6
15	Amir	Sidali	m	Erasmus Hogeschool Brussel	04:11,8
16	Robbe	Elsen	m	Universiteit Hasselt	04:12,2
17	Maxime	Coiff�	m	Universit� Libre de Bruxelles	04:12,7
18	Robin	Demeestere	m	Vrije Universiteit Brussel	04:13,8
19	Jelle	Decoster	m	Universiteit Hasselt	04:14,3
20	Elias	Verdonck	m	Hogeschool Gent	04:15,5
21	Diego	Cassin	m	Katholieke Universiteit Leuven	04:18,5
22	Tim	Vandevelde	m	Universiteit Gent	04:20,1
23	Arjen	De Meyer	m	Universiteit Gent	04:21,0
24	Kobe	Lauwereys	m	Universiteit Gent	04:22,8
25	Nawfel	Benouda	m	HE L�onard de Vinci	04:23,4
26	Wout	De Bal	m	Katholieke Universiteit Leuven	04:25,1
27	Siebe	Desloovere	m	Universiteit Gent	04:39,8
28	Zion	Deberdt	m	Hogeschool VIVES	04:56,6
29	Stan	Devriendt	m	Hogeschool VIVES	05:17,6

## 1500m Dames

Plaats	Voornaam	Naam	Geslacht	Onderwijsinstelling	Resultaat
1	Flore	De Schepper	v	Universiteit Gent	04:51,6
2	EloÃse	Lefevre	v	UniversitÃ© de LiÃge (site de LiÃge)	04:51,8
3	Fiona	Bruno	v	HELÃ©onard de Vinci	04:53,1
4	Marie	Mazzoli	v	UniversitÃ© Catholique de Louvain	05:01,7
5	Margot	Popelier	v	Hogeschool Gent	05:01,9
6	Elea	Buis	v	UniversitÃ© de LiÃge (site de LiÃge)	05:07,2
7	Jinke	Franck	v	Universiteit Gent	05:14,2
8	Femke	Ysewyn	v	Odisee Hogeschool	05:15,9
9	Lilou	Tiberghien	v	UniversitÃ© Catholique de Louvain	06:02,6
10	Charlotte	Roose	v	Arteveldehogeschool	06:36,6

## 3000m heren

Plaats	Voornaam	Naam	Geslacht	Onderwijsinstelling	Resultaat
1	Brice	Degey	m	Universit� de Li� ge (site de Li� ge)	08:32,4
2	Bjarne	Rasschaert	m	Arteveldehogeschool	08:42,8
3	Anas	Abbassi Doukkali	m	HE Francisco Ferrer	08:45,1
4	Martin	Oldenhove	m	Universit� Catholique de Louvain	08:46,9
5	Aron	Claesen	m	Katholieke Universiteit Leuven	08:55,6
6	Louis	Duyckaerts	m	Vrije Universiteit Brussel	08:55,8
7	Simon	Petitjean	m	Universit� Catholique de Louvain	08:58,1
8	Frits	Vanhamme	m	Universit� Catholique de Louvain	09:10,1
9	Sverre	Van Britsom	m	Odisee Hogeschool	09:20,2
10	Louan	Coquer	m	Universit� Catholique de Louvain	09:28,1
11	Briek	Storme	m	Odisee Hogeschool	09:29,1
12	Evariste	Colot	m	HE Louvain en Hainaut	09:42,0
13	Quinten	Van Vorstenbos	m	Artesis Plantijn Hogeschool Antwerpen	10:06,9

## 3000m Dames

Plaats	Voornaam	Naam	Geslacht	Onderwijsinstelling	Resultaat
1	Tine	Demeulenaere	v	Universiteit Antwerpen	10:33,0
2	Ionela	Lecoeuche	v	Arteveldehogeschool	10:50,7
3	Lizzy	Genique	v	Universit� de Mons	10:53,1
4	Jana	Spiessens	v	Artesis Plantijn Hogeschool Antwerpen	11:38,2
5	Elien	Van Nieuwenhoven	v	Universiteit Gent	11:52,1
6	Joke	Lamerant	v	Universiteit Gent	12:30,0
7	Faustine	Viert	v	Universit� Libre de Bruxelles	13:23,6



## 60m horden mannen

Plaats	Voornaam	Naam	Geslacht	Onderwijsinstelling	Resultaat
1	Nolan	Vancauwemberghe	m	Universit� Catholique de Louvain	7,89
2	Iben	Degryse	m	Katholieke Universiteit Leuven	8,16
3	Maxime	Debacker	m	HE Louvain en Hainaut	8,44
4	Siebe	Hauttekeete	m	Universiteit Gent	8,52
5	Thomas	Florkin	m	Universit� Catholique de Louvain	8,53
6	Robin	Henry	m	Universit� Catholique de Louvain	8,66
7	Quinten	Jochems	m	Katholieke Universiteit Leuven	8,73
8	Alexander	Van Vliet	m	Universiteit Gent	8,73
9	Fedde	Eyckmans	m	Katholieke Universiteit Leuven	8,85
10	Ren�	Clinckspoor	m	Hogeschool Gent	9
11	Tibo	Convens	m	Katholieke Universiteit Leuven	9,13
12	M�d�ric	Zgajewski	m	Universit� Catholique de Louvain	9,27
13	Th�odore	Scheere	m	Universit� Libre de Bruxelles	9,38
14	Glen	Van Liefferinge	m	Universiteit Gent	9,48
15	Jonas	Verduyckt	m	Hogeschool Gent	9,49
16	No�	Koch	m	Universit� Catholique de Louvain	9,77
17	Thibaut	Delvin	m	HE Libre de Bruxelles	9,83

## 60m Horden Dames

Plaats	Voornaam	Naam	Geslacht	Onderwijsinstelling	Resultaat
1	Noor	Koekelkoren	v	Arteveldehogeschool	8,33
2	Laures	Bauwens	v	Universiteit Gent	8,4
3	Angel	Agwazie	v	Odisee Hogeschool	8,49
4	Lynn	Beck	v	Katholieke Universiteit Leuven	8,5
5	Emma	De Naeyer	v	Universiteit Gent	8,54
6	RomÃ©e	Smars	v	UniversitÃ© de Mons	8,92
7	Lore	Boonen	v	Katholieke Universiteit Leuven	8,99
8	ZoÃ«	Laureys	v	Universiteit Gent	9,03
9	Emeline	Cleymans	v	UniversitÃ© Catholique de Louvain	9,11
10	Svelte	MariÃ«n	v	Katholieke Universiteit Leuven	9,2
11	ZÃ©lie	Boucquey	v	UniversitÃ© Catholique de Louvain	9,21
12	Amelie	Sonneville	v	Universiteit Gent	9,34
13	Valentine	Ronveaux	v	HE Louvain en Hainaut	9,36
14	LÃ©a	Pinter	v	UniversitÃ© Catholique de Louvain	9,36
15	Nathalie	Bruynseels	v	Universiteit Antwerpen	9,4
16	Frea	Deroost	v	Katholieke Universiteit Leuven	9,43
17	Emma	LengelÃ©	v	UniversitÃ© Catholique de Louvain	9,43
18	Erja	Jerouville	v	UniversitÃ© Catholique de Louvain	9,51
19	Beryl	Owusu	v	Hogeschool Gent	9,58
20	Jutta	Hutsebaut	v	Katholieke Universiteit Leuven	9,58
21	Lotte	Van Masselaer	v	Katholieke Universiteit Leuven	9,58
22	Caro	Vander Avert	v	Karel de Grote Hogeschool	9,73
23	Emeline	Serneels	v	UniversitÃ© de Namur	9,83
24	Maud	Beeckmans	v	Katholieke Universiteit Leuven	9,86
25	ChloÃ©	Bulteau	v	HE Bruxelles - Brabant	12,62

## Kogelstoten Heren

Plaats	Voornaam	Naam	Geslacht	Onderwijsinstelling	Resultaat
1	Andreas	De Lathauwer	m	Odissee Hogeschool	17,04
2	Pieter	Stuyven	m	Arteveldehogeschool	15,87
3	Cédric	Broeckeaert	m	Hogeschool West-Vlaanderen	15,14
4	Leander	Casteels	m	Hogeschool Gent	14,72
5	Arnaud	De Cremer	m	Universiteit Gent	14,54
6	Rafael	De Wit	m	Karel de Grote Hogeschool	14,19
7	Devlin	Neyens	m	Universiteit Hasselt	13,72
8	Robbe	Cherlet	m	Hogeschool Gent	13,05
9	Senne	Prenen	m	Universiteit Hasselt	12,89
10	Jens	Keerman	m	Hogeschool VIVES	11,16
11	Pieter	Spaey	m	Universiteit Gent	10,61
12	François	De Radiguës	m	Université Catholique de Louvain	7,35

## Kogelstoten Dames

Plaats	Voornaam	Naam	Geslacht	Onderwijsinstelling	Resultaat
1	Elena	Defr�re	v	Universiteit Gent	15,25
2	Jo-Anne	Liefooghe	v	Katholieke Universiteit Leuven	13,35
3	Sara	Van Hoyweghen	v	Universiteit Gent	13,13
4	Tjra	Steur	v	Universiteit Gent	12,63
5	Sena	Tay	v	Universiteit Gent	12,15
6	Sennah	Vanhoeijen	v	Universiteit Gent	11,89
7	Martha	Mylle	v	Universiteit Gent	11,58
8	Nathalie	Bruynseels	v	Universiteit Antwerpen	10,58
9	Maxence	Coquyt	v	Hogeschool Gent	10,24
10	Luna	Verhulst	v	Katholieke Universiteit Leuven	9,92
11	Ombeline	Bodart	v	Universit� Libre de Bruxelles	9,36
12	Noor	Amez	v	Katholieke Universiteit Leuven	9,27
13	Elise	Poot	v	Universit� Catholique de Louvain	8,37
14	Xandrine	Scheurwegen	v	Universiteit Gent	8,35
15	Helena	Oste	v	Universiteit Gent	8,17
16	Lucie	Hoffer	v	Universit� Catholique de Louvain	7,32

## Hoogspringen heren

Plaats	Voornaam	Naam	Geslacht	Onderwijsinstelling	Resultaat
1	Chao-Yuan	Liu	m	Katholieke Universiteit Leuven	1,95
2	Wout	Degrande	m	Katholieke Universiteit Leuven	1,95
3	Wout	Eussen	m	Universiteit Hasselt	1,9
4	Yoran	Vandekerckhove	m	Karel de Grote Hogeschool	1,9
5	Marc	Zgajewski	m	Universit� Catholique de Louvain	1,9
6	Martin	Reip	m	HE de la Province de Li�ge	1,9
7	Kwinten	Torfs	m	Katholieke Universiteit Leuven	1,9
8	Devlin	Neyens	m	Universiteit Hasselt	1,85
9	Sam	De Deyn	m	Universiteit Gent	1,85
10	Glen	Van Liefferinge	m	Universiteit Gent	1,85
11	Otis	Van Kerm	m	Universit� Catholique de Louvain	1,8
12	Jean-Paul	Ngongo-Essomba	m	Universit� Catholique de Louvain	1,7
13	Abdssamad	Hguiggach	m	Universit� Catholique de Louvain	1,5

## Hoogspringen Dames



Plaats	Voornaam	Naam	Geslacht	Onderwijsinstelling	Resultaat
1	Yorunn	Ligneel	v	Katholieke Universiteit Leuven	1,73
2	Maud	Beeckmans	v	Katholieke Universiteit Leuven	1,6
3	Ubi	Terpstra	v	Universiteit Gent	1,6
3	Lise	Braux	v	Universit� Catholique de Louvain	1,6
3	Louise	Sodahlon	v	Universiteit Gent	1,6
6	Antje	De Schryver	v	Hogeschool Gent	1,55
7	Cassandra	Theyskens	v	Universit� Catholique de Louvain	1,55
8	Ombeline	Bodart	v	Universit� Libre de Bruxelles	1,5
9	Sasha	Jordens	v	HE Louvain en Hainaut	1,45

## Hinkstap springen heren



Plaats	Voornaam	Naam	Geslacht	Onderwijsinstelling	Resultaat
1	Tommy	Soumahoro	m	Universit� Libre de Bruxelles	14,07
2	Lo�c	Bass�g	m	HEL�onard de Vinci	14,02
3	Isma�l	Diam�	m	HEL�onard de Vinci	13,38
4	Fedde	Eyckmans	m	Katholieke Universiteit Leuven	13,21
5	Brent	Gayse	m	Katholieke Universiteit Leuven	12,34
6	Alexis	Van Elsuw�	m	Universit� Libre de Bruxelles	11,79

## Hinkstap springen Dames

Plaats	Voornaam	Naam	Geslacht	Onderwijsinstelling	Resultaat
1	Ilona	Masson	v	HE de la Province de Liège	13,09
2	Margot	Delbare	v	Universiteit Hasselt	12,04
3	Geraldine	Dheur	v	Université Catholique de Louvain	11,68
4	Jenna	Vermeulen	v	Universiteit Gent	11,05
5	Jolijn	Verhaeghe	v	Katholieke Universiteit Leuven	11
6	Elise	Depreiter Malysse	v	Katholieke Universiteit Leuven	10,97
7	Léa	Gomez-Marin	v	Université de Liège (site de Liège)	10,83
8	Axelle	Praet	v	Universiteit Gent	10,82
9	Jana	Horemans	v	Universiteit Hasselt	10,73
10	Sara	Vanhalst	v	Vrije Universiteit Brussel	10,67
11	Emeline	Serneels	v	Université de Namur	10,5



## Polsstokspringen heren

Plaats	Voornaam	Naam	Geslacht	Onderwijsinstelling	Resultaat
1	Pierre	Straet	m	Universit� Catholique de Louvain	4,91
2	Cl�ment	Lanotte	m	Ecole Pratiques des Hautes �tudes Commer	4,81
3	Martin	Reip	m	HE de la Province de Li�ge	4,71
4	Jorg	Vanlierde	m	Arteveldehogeschool	4,71
5	Victor	Priem	m	Hogeschool Gent	4,71
6	Hugo	Barthelemy	m	Universit� Catholique de Louvain	4,61
7	Lo�c	Joannes	m	Universit� de Li�ge (site de Li�ge)	4,61
8	Alexandre	Pinte	m	Universit� de Li�ge (site de Li�ge)	4,61
9	Jonas	Vander Avert	m	Artesis Plantijn Hogeschool Antwerpen	4,41
10	Rune	Ginkels	m	Katholieke Universiteit Leuven	4,21

## Polsstokspringen Dames



Plaats	Voornaam	Naam	Geslacht	Onderwijsinstelling	Resultaat
1	Fleur	Hooyberghe	v	Universiteit Gent	4,01
2	Caroline	Bloch	v	HE de la Province de Liège	3,51
3	Clémence	Huybens	v	Université Catholique de Louvain	3,41
4	Hanne	Vandenbroucke	v	Vrije Universiteit Brussel	3,21
5	Dag-Ferene	Van Cappellen	v	Vrije Universiteit Brussel	3,21
6	Lise	Morren	v	Katholieke Universiteit Leuven	3,01
6	Lilou	Moreau	v	Université Catholique de Louvain	3,01
8	Margot	Neyrinck	v	Université Libre de Bruxelles	2,81

## Verspringen heren





Plaats	Voornaam	Naam	Geslacht	Onderwijsinstelling	Resultaat
1	Loïc	Bassac	m	HE Conard de Vinci	6,89
2	Jonas	Vander Avert	m	Artesis Plantijn Hogeschool Antwerpen	6,77
3	Simon	Dekoninck	m	Hogeschool UC Leuven	6,64
4	Rune	Wyns	m	Katholieke Universiteit Leuven	6,61
5	Wout	Noppe	m	Hogeschool Gent	6,43
6	Liam	Sprangers	m	Universiteit Gent	6,32
7	Thibaut	Delvin	m	HE Libre de Bruxelles	6,2
8	Jonas	Verduyck	m	Hogeschool Gent	6,13
9	Renzo	Van de Vyvere	m	Universiteit Gent	6,07
10	Enzo	Mayuma	m	HE Louvain en Hainaut	6
11	Robin	Henry	m	Université Catholique de Louvain	5,89
12	Elouan	Lanier	m	HE Libre de Bruxelles	5,74
13	Bilal	Hammane	m	Hogeschool West-Vlaanderen	5,24

Plaats	Voornaam	Naam	Geslacht	Onderwijsinstelling	Resultaat
1	Maité	Beermaert	v	Katholieke Universiteit Leuven	6,11
2	Laura	Van den Brande	v	Universiteit Gent	5,79
3	Geraldine	Dheur	v	Université Catholique de Louvain	5,56
4	Noa	Buis	v	Université de Liège (site de Liège)	5,53
5	Yelena	Boone	v	Universiteit Gent	5,35
6	Soraya	De Sousa Moreira	v	HELiConard de Vinci	5,3
7	Jolijn	Verhaeghe	v	Katholieke Universiteit Leuven	5,26
8	Marie-Jo	Desplenter	v	Hogeschool VIVES	5,23
9	Thaïs	Favoreel	v	Universiteit Gent	5,22
10	Jenna	Vermeulen	v	Universiteit Gent	5,2
11	Zoe	Devillé	v	Hogeschool PXL	5,15
12	Anne-Dominique	Baramoto	v	Vrije Universiteit Brussel	5,13
13	Elise	Depreiter Malysse	v	Katholieke Universiteit Leuven	5,07
14	Léa	Gomez-Mariné	v	Université de Liège (site de Liège)	5,02
15	Bo	Rens	v	Artesis Plantijn Hogeschool Antwerpen	4,97
16	Fleur	Deschaux	v	HELiConard de Vinci	4,75
17	Lucie	Hoffer	v	Université Catholique de Louvain	4,25

## Estafette 4x200m Heren

#	Relay team	Club	N...	Result	C...
1	 <b>Starving Wolves</b> H. Piengeon - M. Latinne - A. Bouchat - T. Florkin	Université Catholique de Louvain	4	<b>1:29,72</b>	---
2	 <b>Helha Tigers</b> M. Debacker - E. Bossicard - T. Rositano - F. Dehout	HE Louvain en Hainaut	4	<b>1:29,85</b>	---
3	 <b>Kern De Pinte</b> S. Hautekeete - T. Vanmarsenille - A. Van Vliet - G. Van Liefferinge	Universiteit Gent	4	<b>1:36,21</b>	---
4	 <b>Thunderwolves</b> M. Zgajewski - L. Dejasse - R. Henry - S. Azzouz	Université Catholique de Louvain	4	<b>1:36,83</b>	---
5	 <b>Runningwolves</b> L. Lucion - V. Mullens - J. Wilmet - A. Hguiggach	Université Catholique de Louvain	4	<b>1:42,94</b>	---
6	 <b>Wolves Brigade</b> F. Albert - A. Pisetta - R. Van Hees - L. Pecheur	Université Catholique de Louvain	4	<b>1:44,94</b>	---
	 <b>The Wolves Squad</b> E. Latinne - N. Scarniet - C. Annet - R. Jacques	Université Catholique de Louvain	4	<b>DNF</b>	---

## Estafette 4x200m dames

#	Relay team	Club	N...	Result	C...
1	 <b>Les Wolfies</b> C. Nsiala Kapinga Katanga - Z. Boucquey - G. Dheur - C. O'Shea	Université Catholique de Louvain	4	<b>1:45,68</b>	---
2	 <b>As rieme</b> M. Lagaeyse - J. De Pape - E. De Muynck - M. Temmerman	Universiteit Gent	4	<b>1:53,60</b>	---
3	 <b>WolvesInWhite</b> E. Jerouville - M. Mortamet - C. Scheirlinckx - N. Huynh	Université Catholique de Louvain	4	<b>1:55,69</b>	---
	 <b>Wolfgang</b> L. Hoffer - O. de Vinck - L. Tiberghien - L. Thomas	Université Catholique de Louvain	4	<b>DQ</b>	---

Résultats du Championnat FSUB  
d'Athlétisme Outdoor  
SMAC- ADEPS La Mosane à Jambes  
Mercredi 1 mai 2024



**Résultats : 4 x 100m - TC W**

Tour : \*

• **Série : 1****OFFICIEL** (18:22:39)

Pos.	Doss.	Athlète	Cat.	Année	Cercle	Perf.	Pts	Pts. Eq.	Infos
1		<b>UCLouvain Wolves 1</b>				<b>53.49</b>	0		
	6349	Jérouville, Erja	U23 W	2003	UCLou				
	6208	Scheirlinckx, Chloé	SEN W	2001	vainW-				
	9954	Mortamet, Margot	U23 W	2002	BBS				
	6479	Huynh, Nathalie	SEN W	2001	UCLou vainW- RIWA UCLou vainW- FRA UCLou vainW- RCB				
2		<b>UCLouvain Wolves 2</b>				<b>55.45</b>	0		
	6198	Poot, Elise	U23 W	2002	UCLou				
	5002	Martin, Lucie	JUN W	2005	vainW-				
	9940	Bachul, Ewa	SEN W	1999	USTA				
	9936	Michel, Juliette	JUN W	2005	UCLou vainW- CSDY UCLou vainW- NA UCLou vainW- FRA				
3		<b>UCL Wolfgang</b>				<b>59.50</b>	0		
	9984	Happaerts, Lucie	U23 W	2004	NA				
	9908	De Vinck, Olga	U23 W	2004	UCLou				
	9929	Tiberghien, Lilou	U23 W	2004	vainW-				
	9985	Thomas, Leah	SEN W	2001	NA UCLou vainW- NA NA				

**Résultats : 4 x 100m - TC M**

Tour : \*

• **Série : 1****OFFICIEL** (18:27:39)

Pos.	Doss.	Athlète	Cat.	Année	Cercle	Perf.	Pts	Pts. Eq.	Infos
1		<b>KU Leuven perchistes</b>				<b>45.78</b>	0		
	4358	Ginkels, Rune	JUN M	2005	KU				
	6252	Van Hemelryck, Simon	U23 M	2003	Leuve				
	5144	Degrande, Wout	U23 M	2004	n-				
	1487	Stavart, Pierre	U23 M	2004	ROBA KU Leuve n-RCT				





Pos.	Doss.	Athlète	Cat.	Année	Cercle	Perf.	Pts	Pts. Eq.	Infos
2		<b>UCLouvain Wolves</b>				<b>47.43</b>	0		
	711	Zgajewski, Mederic	SEN M	1999	UCLou				
	9955	Deramaix, Félix	JUN M	2005	vainW-				
	9930	Hguiggach, Abdssamad	JUN M	2005	ACLO				
	9918	Pisetta, Antoine	U23 M	2004	UCLou vainW- NA UCLou vainW- NA UCLou vainW- NA				
3		<b>OPEN-OCAN</b>				<b>48.20</b>	0		
	310	De Radigues, Thibaut	JUN M	2005	EPHE				
	521	Regaert, Simon	U23 M	2004	C-				
	8	Lefebvre, Tom	JUN M	2005	OCAN				
	9932	Demortier, Robin	U23 M	2004	ULiège Lg- OCAN HEPL- OCAN HECh- NA				

## Résultats : 4 x 400m - TC W

Tour : \*

- [Aperçu total des résultats](#)

## Résultats : 4 x 400m - TC M

Tour : \*

- [Série : 1](#) **OFFICIEL** (18:39:33)

Pos.	Doss.	Athlète	Cat.	Année	Cercle	Perf.	Pts	Pts. Eq.	Infos
1		<b>UCL Staring wolves</b>				<b>3:22.89</b>	0		
	248	Latinne, Ethan	JUN M	2005	UCLou				
	1381	Bouchat, Arthur	U23 M	2002	vainW-				
	1236	Jacques, Romain	U23 M	2004	WS				
	676	Piengeon, Hadrien	SEN M	2000	UCLou vainW- SMAC UCLou vainW- SMAC UCLou vainW- CABW				

Pos.	Doss.	Athlète	Cat.	Année	Cercle	Perf.	Pts	Pts. Eq.	Infos
2		<b>UCLouvain Wolves 2</b>				<b>3:40.85</b>	0		
	517	Scarniet, Nicolas	U23 M	2004	UCLou				
	629	Pecheur, Louis	U23 M	2003	vainW-				
	512	De Radigues, François	SEN M	2000	ACLO				
	711	Zgajewski, Mederic	SEN M	1999	UCLou vainW- ULA UCLou vainW- OCAN UCLou vainW- ACLO				
3		<b>HEPHC-NA</b>				<b>3:46.38</b>	0		
	9983	Thiry, Lillian	U23 M	2002	HEPH				
	9981	Lelong, Raphaël	JUN M	2005	C-NA				
	9982	Dawael, Alexis	U23 M	2002	HEPH				
	9980	Medici, Nando	SEN M	2000	C-NA HEPH C-NA HEPH C-NA				
4		<b>OPEN-OCAN</b>				<b>3:50.10</b>	0		
	521	Regaert, Simon	U23 M	2004	ULiège				
	8	Lefebvre, Tom	JUN M	2005	Lg-				
	310	De Radigues, Thibaut	JUN M	2005	OCAN				
	9932	Demortier, Robin	U23 M	2004	HEPL- OCAN EPHE C- OCAN HECh- NA				



**Résultats : 100m - TC W - Séries****Tour : \***• **Série : 1****OFFICIEL** (13:57:32) Vent : +2.5 m/s

Pos.	Doss.	Athlète	Cat.	Année	Cercle	Perf.	Infos
1	6108	Mortant, Alexandra	U23 W	2004	UCLouvainW-CABW	11.77	
2	6156	Morency Poilvache, Alizée	SEN W	1998	ULB OWLS-RESC	11.83	
3	1545	Agwazie, Angel	SEN W	2001	ODISE E-OEH	11.94	
4	1479	Beck, Lynn	SEN W	2001	KU Leuven-AVLL	11.95	
5	6465	Duchene, Aurore	SEN W	2000	OPEN-CABW	12.29	
6	5267	Nsiala Kapinga Katanga, Christelle	JUN W	2005	UCLouvainW-CSF	12.30	
7	1634	Anyanwu, Valentine	U23 W	2004	UCLLeuven-ACG	12.45	
8	1406	Porton, Chloë	SEN W	2000	VUB-DCLA	12.48	

• **Série : 2****OFFICIEL** (13:57:32) Vent : +2.1 m/s

Pos.	Doss.	Athlète	Cat.	Année	Cercle	Perf.	Infos
1	6046	Bosquet, Aline°	SEN W	1999	ULB OWLS-CSF	12.38	
2	6025	Buis, Noa	U23 W	2003	ULiège Lg-FCHA	12.66	
3	1509	De Troyer, Lisa	U23 W	2004	HOGE NT-LEBB	12.73	
4	5083	Ponchione, Sara	JUN W	2006	AP-DAMP	12.75	
5	6349	Jérouville, Erja	U23 W	2003	UCLouvainW-BBS	12.80	
6	6124	Penalver Garcia, Monica	SEN W	1999	HE Vinci-RCAS	13.01	
7	6380	Renkin, Emma	SEN W	1997	ULiège Lg-WACO	13.11	
8	6126	sevrin, Laure°	SEN W	2001	AP-RCAS	13.32	



- **Série : 3** **OFFICIEL** (13:57:28) Vent : +2.1 m/s

Pos.	Doss.	Athlète	Cat.	Année	Cercle	Perf.	Infos
1	6383	Lakhdar, Nassera	SEN W	2001	UCLou vainW- RCAS	13.04	
2	6198	Poot, Elise	U23 W	2002	UCLou vainW- USTA	13.28	
3	6355	Alegre, Julia	U23 W	2003	ULiège Lg- HERV	13.70	
4	5002	Martin, Lucie	JUN W	2005	UCLou vainW- CSDY	13.99	
5	9936	Michel, Juliette	JUN W	2005	UCLou vainW- FRA	14.13	
6	6339	Domaniecki, Céline	SEN W	1997	OPEN- MOHA	14.26	
7	6479	Huynh, Nathalie	SEN W	2001	UCLou vainW- RCB	14.55	
8	5252	Flamand, Thais	JUN W	2006	OPEN- CSDY	15.34	

## Résultats : 100m - TC M - Séries

Tour : \*

- **Série : 1** **OFFICIEL** (14:23:20) Vent : +0.9 m/s

Pos.	Doss.	Athlète	Cat.	Année	Cercle	Perf.	Infos
1	6271	Devriendt, Adrien	U23 M	2002	VIVES- ACME	10.60	
2	885	Laurent, Luca	U23 M	2004	OPEN- SMAC	10.62	
3	1064	Nsangolo, Jean-Charles	SEN M	1996	OPEN- CSF	10.65	
4	1305	Tshitwenu, Florian	SEN M	1997	EPHEC -RESC	10.80	
5	671	Dehout, Floran	SEN M	2001	HELHa -CABW	10.86	
6	1250	Léonard, Nicolas	SEN M	1999	OPEN- BBS	11.15	
7	542	Debacker, Maxime	SEN M	2001	HELHa -OSGA	11.15	
8	1341	Szerman, Melvin	SEN M	1997	OPEN- WS	11.29	

- **Série : 2** **OFFICIEL** (14:23:20) Vent : +2.1 m/s

Pos.	Doss.	Athlète	Cat.	Année	Cercle	Perf.	Infos
1	1454	Renard, Victor	SEN M	1998	OPEN- ATC	10.70	

Pos.	Doss.	Athlète	Cat.	Année	Cercle	Perf.	Infos
2	1298	Sampson, Yanni	U23 M	2004	HELMo -RFCL	10.90	
3	56	Kalut, Antoine	JUN M	2005	HEPL- FCHA	11.03	
4	703	Loforte, Matéo	SEN M	2000	HELMo -SER	11.08	
5	1080	Annet, Corentin	U23 M	2004	UCLou vainW- BBS	11.09	
6	5190	Van Den Bulcke, Jasper	U23 M	2003	UGent- LEBB	11.17	
7	240	Van Hove, Mathys	JUN M	2005	ULB OWLS- CSF	11.40	
8	298	Schuermans, Adrien	JUN M	2005	AP-WS	11.54	

• **Série : 3****OFFICIEL** (14:23:20)

Vent : +1.7 m/s

Pos.	Doss.	Athlète	Cat.	Année	Cercle	Perf.	Infos
1	1065	Guineberteau, Thibault	U23 M	2002	HE2B- CSF	11.43	
2	1180	Klein, Arnaud	SEN M	2001	ULB OWLS- CSF	11.52	
3	517	Scarniet, Nicolas	U23 M	2004	UCLou vainW- ACLO	11.74	
4	802	Antonutti, Adrien	U23 M	2003	UCLou vainSL- SMAC	11.86	
5	687	Danno, Titouan	U23 M	2003	ULB OWLS- RCAS	12.01	
6	1262	Anani, Komi Daniel	SEN M	1999	EHB- CSF	12.01	
7	1487	Stavart, Pierre	U23 M	2004	KU Leuven -CSDY	12.04	

• **Série : 4****OFFICIEL** (14:23:20)

Vent : +3.2 m/s

Pos.	Doss.	Athlète	Cat.	Année	Cercle	Perf.	Infos
1	1333	Scarniet, François	SEN M	1993	OPEN- ACLO	11.48	
2	1090	Claes, Melvyn	SEN M	2001	UCLou vainW- USTA	11.52	
3	574	Hella, Guillaume	SEN M	1994	OPEN- WACO	11.74	
4	1458	Mabille, Robin	SEN M	1999	UCLou vainW- CSDY	11.91	

Pos.	Doss.	Athlète	Cat.	Année	Cercle	Perf.	Infos
5	9960	Salmon, Emile	U23 M	2002	ULB OWLS-NA	12.11	
6	9955	Deramaix, Félix	JUN M	2005	UCLouvainW-NA	12.47	
7	9931	Belle, Aurélien	U23 M	2002	HELHa-NA	12.88	

• **Série : 5****OFFICIEL** (14:23:20)

Vent : +3.7 m/s

Pos.	Doss.	Athlète	Cat.	Année	Cercle	Perf.	Infos
1	1179	Bondue, Jason	SEN M	2001	ULB OWLS-CSF	10.83	
2	4148	De Rooze, Jurian	JUN M	2005	KU Leuven-DCLA	11.22	
3	6208	Mazina, Mugarura Shaka	U23 M	2004	OPEN-DCLA	11.82	
4	256	Asamoah, Melvyn	JUN M	2005	OPEN-RCAS	12.15	
5	9918	Pisetta, Antoine	U23 M	2004	UCLouvainW-NA	12.19	
6	9946	Rubio, Michel	U23 M	2002	ULB OWLS-NA	12.80	
7	1036	Vico, Tobias	U23 M	2003	ULB OWLS-MOHA	12.88	

**Résultats : 400mH 0,762m - TC W****Tour : \***• **Série : 1****OFFICIEL** (14:34:46)

Pos.	Doss.	Athlète	Cat.	Année	Cercle	Perf.	Infos
1	1270	Hespel, Nina	SEN W	2001	KU Leuven-DCLA	58.57	
2	6120	Dheur, Géraldine	SEN W	2000	UCLouvainW-RCAS	1:02.20	
3	5238	Boucquey, Zélie	JUN W	2005	UCLouvainW-RCB	1:02.64	
4	6098	Lefevre, Charline	U23 W	2002	ULiège Lg-SER	1:05.13	
	233	Laureys, Zoë	JUN W	2005	UGent-DUFF	DNF	

• **Série : 2** **OFFICIEL** (14:34:46)

Pos.	Doss.	Athlète	Cat.	Année	Cercle	Perf.	Infos
1	6183	Possen, Anna	U23 W	2004	ULiège Lg- RFCL	1:10.20	
2	1002	Vermaelen, Anke	SEN W	2000	OPEN- DCLA	1:10.39	
3	5022	Somville, Margot	JUN W	2006	OPEN- FLEU	1:12.27	
4	6182	Hensenne, Eva	SEN W	2001	OPEN- RFCL	1:14.95	

## Résultats : 400mH 0,914m - TC M

**Tour : \***

• **Série : 1** **OFFICIEL** (14:35:18)

Pos.	Doss.	Athlète	Cat.	Année	Cercle	Perf.	Infos
1	1108	Henry, Robin	SEN M	2001	UCLou vainW- BBS	54.57	
2	5087	Romswinkel, Nils	U23 M	2003	UGent- OB	55.75	
3	5686	Hauttekeete, Siebe	U23 M	2004	UGent- KAAG	55.88	
4	663	Schyns, Alexandre	SEN M	1998	OPEN- SER	56.68	
5	270	Malkic, Pierre	JUN M	2005	ULB OWLS- RCB	56.79	
6	1069	Ruth, Jerome	SEN M	1997	OPEN- RFCL	58.26	
7	952	Dumortier, Romain	SEN M	2001	ULiège Lg-SPA	59.64	
8	1079	Provoost, Noa	U23 M	2004	ULiège Lg- HERV	1:03.39	

## Résultats : 400m - TC W

**Tour : \***

• **Série : 1** **OFFICIEL** (15:07:00)

Pos.	Doss.	Athlète	Cat.	Année	Cercle	Perf.	Infos
1	1485	Steenmans, Jitse	SEN W	2000	KU Leuven -AVLL	56.88	
2	1493	De Smet, Jenna	U23 W	2002	UGent- KAAG	57.27	

Pos.	Doss.	Athlète	Cat.	Année	Cercle	Perf.	Infos
3	1305	Sonneville, Amelie	U23 W	2004	UGent-KAAG	57.89	
4	6303	Broze, Emma	SEN W	2000	HE Vinci-CABW	58.13	
5	1413	Jacobs, Claire	U23 W	2004	KU Leuven-DCLA	59.58	
6	3	Hermans, Janne	JUN W	2006	OPEN-DCLA	1:00.10	

• **Série : 2** **OFFICIEL** (15:07:00)

Pos.	Doss.	Athlète	Cat.	Année	Cercle	Perf.	Infos
1	1404	Ex, Eveline	U23 W	2004	KU Leuven-DCLA	59.98	
2	5146	Bonjean, Lucie	JUN W	2005	ICHEC-ECAM-SMAC	1:00.27	
3	6350	Scutnaire, Léa	U23 W	2004	HEPHC-OSGA	1:02.06	
4	6032	Paulart, Amélie	U23 W	2004	HELHa-OSGA	1:04.47	
	9954	Mortamet, Margot	U23 W	2002	UCLouvainW-FRA	DNS	Perf. Hom. :DNS

## Résultats : 400m - TC M

**Tour : \***

• **Série : 1** **OFFICIEL** (14:54:33)

Pos.	Doss.	Athlète	Cat.	Année	Cercle	Perf.	Infos
1	817	Mengal, Simon	SEN M	1995	OPEN-USBW	47.65	
2	6118	Bex, Wout	U23 M	2002	UGent-KAAG	48.43	
3	676	Piengeon, Hadrien	SEN M	2000	UCLouvainW-CABW	48.80	
4	712	Jacques, Geoffrey	SEN M	2001	OPEN-SER	49.01	
5	1381	Bouchat, Arthur	U23 M	2002	UCLouvainW-SMAC	49.32	
6	756	Lins, Sébastien	SEN M	1992	OPEN-RESC	50.25	
7	248	Latinne, Ethan	JUN M	2005	UCLouvainW-WS	50.29	



• **Série : 2** **OFFICIEL** (14:54:33)

Pos.	Doss.	Athlète	Cat.	Année	Cercle	Perf.	Infos
1	6017	van der Deure, Jelle°	U23 M	2002	KU Leuven -DCLA	50.37	
2	525	Lavigne, Simon	SEN M	2001	HENAL LUX- DAMP	50.68	
3	1236	Jacques, Romain	U23 M	2004	UCLou vainW- SMAC	50.95	
4	957	Schauwers, François	SEN M	1996	ULiège Lg-SPA	51.38	
5	1254	Ilunga, Carl	SEN M	1993	OPEN- RESC	51.50	
6	602	Bodart, Antoine	SEN M	1996	OPEN- SMAC	52.19	
7	664	Vervinckt, Maxant	SEN M	1996	AP- SMAC	52.62	

• **Série : 3** **OFFICIEL** (14:54:33)

Pos.	Doss.	Athlète	Cat.	Année	Cercle	Perf.	Infos
1	254	Cimino, Gilles	JUN M	2005	HE Vinci- WS	51.83	
2	631	Spigeleer, Nicolas	SEN M	1996	OPEN- USBW	52.15	
3	5934	De Hertogh, Milan	U23 M	2004	KU Leuven -ACKO	52.64	
4	329	Herbay, Théo	JUN M	2005	UCLou vainW- SMAC	53.07	
5	4236	Jacobs, Nanno	JUN M	2006	OPEN- DCLA	53.39	
6	690	Laloux, Pierre	SEN M	1997	UCLou vainW- RCAS	53.96	
7	1167	Dejasse, Lois	U23 M	2004	UCLou vainW- CSDY	54.57	

• **Série : 4** **OFFICIEL** (14:54:33)

Pos.	Doss.	Athlète	Cat.	Année	Cercle	Perf.	Infos
1	4323	Celis, William	JUN M	2006	OPEN- ROBA	52.83	
2	241	Goossens, Antoine	JUN M	2005	HEPHC -ACBB	54.74	
3	2225	Laus, Joachim	M35	1984	OPEN- ACBB	55.40	

Pos.	Doss.	Athlète	Cat.	Année	Cercle	Perf.	Infos
4	6383	Breugelmans, Kwinten	U23 M	2002	KU Leuven -DCLA	56.50	
5	819	Vanhournout, Camile	U23 M	2004	HELHa -OSGA	57.32	
6	9930	Hguiggach, Abdssamad	JUN M	2005	UCLou vainW- NA	59.36	

## Résultats : 800m - TC W

Tour : \*

- **Série : 1** OFFICIEL (15:40:25)

Pos.	Doss.	Athlète	Cat.	Année	Cercle	Perf.	Infos
1	6011	Collin, Amélie	SEN W	2001	HENAL LUX- UAC	2:11.42	
2	6118	Grandjean, Lucie	U23 W	2003	UCLou vainW- BBS	2:12.18	
3	6129	Bruno, Fiona	SEN W	2001	AP- OSGA	2:13.70	
4	1806	Vereecke, Hanna	SEN W	2000	VUB- KAAG	2:15.29	
5	6377	Callebaut, Ange-Victoria	SEN W	1999	EPHEC -WS	2:17.39	
6	6024	Buis, Éléa	SEN W	2001	ULiège Lg- FCHA	2:17.49	
7	5043	De Brouwer, Josephine	JUN W	2005	VUB- CSF	2:20.81	
8	6131	Taminiau, Elise	U23 W	2004	UCLou vainW- ACCO	2:28.45	
9	6310	Fernandes, Noemie	U23 W	2002	HELHa -MOHA	2:48.58	
10	9908	De Vinck, Olga	U23 W	2004	UCLou vainW- NA	2:50.10	
11	5264	Hespeel, Zelie	JUN W	2006	OPEN- ACBB	2:50.32	

## Résultats : 800m - TC M

Tour : \*

- **Série : 1** OFFICIEL (15:40:57)

Pos.	Doss.	Athlète	Cat.	Année	Cercle	Perf.	Infos
1	6176	Bafort, Joachim	SEN M	2001	UGent- RIEM	1:55.02	

Pos.	Doss.	Athlète	Cat.	Année	Cercle	Perf.	Infos
2	5441	Soetens, Brent	U23 M	2002	UGent- EA	1:57.69	
3	9935	Collins, Ted	U23 M	2002	UCLou vainW- IRL	1:58.80	
4	794	Bovy, Victor	U23 M	2002	ULiège Lg- RFCL	1:59.72	
5	544	Lengelé, Antoine	U23 M	2003	UMON S- OSGA	2:00.37	
6	99	Jurion, Cyril	JUN M	2005	ULiège Lg-SPA	2:00.45	
7	505	Heroufousse, Baptiste	U23 M	2002	UCLou vainW- CSDY	2:00.60	
8	707	Lucion, Alexandre	SEN M	1990	OPEN- ACLO	2:03.67	
9	727	Bayard, Julien	U23 M	2002	HEPL- SER	2:06.38	

• **Série : 2** **OFFICIEL** (15:40:57)

Pos.	Doss.	Athlète	Cat.	Année	Cercle	Perf.	Infos
1	9905	Brandt, François	JUN M	2005	UCLou vainW- NA	2:03.10	
2	307	de Thysebaert, Arthur	JUN M	2005	AP-WS	2:03.72	
3	774	Masschaele, Arnaud	U23 M	2003	HENAL LUX- ARCH	2:04.81	
4	1237	Bastin, Lucas	U23 M	2003	HENAL LUX- SMAC	2:05.42	
5	629	Pecheur, Louis	U23 M	2003	UCLou vainW- ULA	2:07.34	
6	5003	Vermaelen, Maarten	U23 M	2003	VUB- DCLA	2:10.51	
7	9906	Albert, Florent	U23 M	2004	UCLou vainW- NA	2:19.96	
8	9939	Dubucq, Léopold	U23 M	2003	UCLou vainW- NA	2:20.66	
9	48	Crauwels, Louis	JUN M	2005	KU Leuven -RFCL	2:23.96	
10	9948	Léonard, Martin	SEN M	2000	EPHEC -NA	2:34.00	

## Résultats : 1500m - TC W

Tour : \*

- **Série : 1** **OFFICIEL** (15:59:33)

Pos.	Doss.	Athlète	Cat.	Année	Cercle	Perf.	Infos
1	6236	Mazzoli, Marie	U23 W	2002	UCLou vainW- DAMP	4:49.20	
2	1168	Van Laethem, Delphine	SEN W	1995	VUB- EA	4:50.12	
3	1353	Meert, Soraya	SEN W	1993	OPEN- EA	4:52.22	
4	5133	Genique, Lizzy	JUN W	2006	UMON S- MOHA	4:56.02	
5	6578	Hübinger, Lynn	U23 W	2004	UCLou vainW- LACE	5:04.80	
6	6545	Gonne, Sarah	U23 W	2004	OPEN- OSGA	5:17.44	
7	6488	Parmantier, Lisa	U23 W	2003	ULB OWLS- RCB	5:18.30	
8	8370	Richir Deville, Nina	CAD W	2009	CSF	5:23.06	
9	9929	Tiberghien, Lilou	U23 W	2004	UCLou vainW- NA	5:46.78	
	1505	Fayt, Karl	SEN M	2000	UCLou vainW- CSDY		

**Résultats : 1500m - TC M**Tour : \*

- **Série : 1** **OFFICIEL** (16:14:43)

Pos.	Doss.	Athlète	Cat.	Année	Cercle	Perf.	Infos
1	5507	Claesen, Aron	SEN M	2001	KU Leuven -ATLA	4:01.67	
2	1177	Schauwers, Antoine	SEN M	2001	ULiège Lg-SPA	4:02.24	
3	1361	Douley, Antoine	SEN M	1995	OPEN- SMAC	4:02.50	
4	567	Mullens, Victor	U23 M	2004	UCLou vainW- HUY	4:02.87	
5	1016	Sidali, Amir	SEN M	2001	EHB- WS	4:03.81	
6	1094	Lelievre, Thibault	U23 M	2003	UCLou vainW- WS	4:04.53	

Pos.	Doss.	Athlète	Cat.	Année	Cercle	Perf.	Infos
7	527	Belsack, Cyrill	U23 M	2004	HELHa -CRAC	4:05.86	
8	638	Bourez, Nicolas	U23 M	2002	UCLou vainW- USBW	4:06.50	
9	1329	Duysinx, Tom	U23 M	2004	ULiège Lg- HUY	4:09.79	
10	506	Houssiere, Pierre	U23 M	2002	UCLou vainW- CSDY	4:12.33	
11	6556	Sakouane Zaghdoud, Ilyas°	SCO M	2007	CSF	4:16.52	
12	1166	De Cumont, Gaston	U23 M	2004	UCLou vainW- RCB	4:17.39	
13	9912	Benouda, Nawfel	SEN M	1999	HE Vinci- NA	4:19.31	
14	661	Bassou, Adam	U23 M	2004	ULiège Lg-SER	4:19.68	
15	639	Bourez, Robin	SEN M	2001	UNAM UR- USBW	4:24.70	
16	71	Houbart, Martin	JUN M	2005	HELMo -HUY	4:34.56	
17	990	Clinquart, François	U23 M	2004	UCLou vainW- CSDY	4:37.95	

## Résultats : 100mH 0,838m - TC W

Tour : \*

• **Série : 1**

**OFFICIEL** (16:23:00)

Vent : +2.5 m/s

Pos.	Doss.	Athlète	Cat.	Année	Cercle	Perf.	Infos
1	1545	Agwazie, Angel	SEN W	2001	ODISE E-OEH	13.46	
2	288	Koekelkoren, Noor	JUN W	2005	ARTVE LDE- DCLA	13.73	
3	6108	Mortant, Alexandra	U23 W	2004	UCLou vainW- CABW	13.74	
4	1739	De Naeyer, Emma	U23 W	2002	UGent- ACME	14.06	
5	69	D'hondt, Luca	JUN W	2006	OPEN- PEGA	14.16	
6	1479	Beck, Lynn	SEN W	2001	KU Leuven -AVLL	14.17	

- **Série : 2** **OFFICIEL** (16:23:00) Vent : +2.5 m/s

Pos.	Doss.	Athlète	Cat.	Année	Cercle	Perf.	Infos
1	6244	Smars, Romée	SEN W	2001	UMON S- CABW	14.59	
2	5238	Boucquey, Zélie	JUN W	2005	UCLou vainW- RCB	14.75	
3	6349	Jérouville, Erja	U23 W	2003	UCLou vainW- BBS	15.21	
4	6367	Cleymans, Emeline	SEN W	2001	UCLou vainW- SMAC	15.59	
5	5265	Serneels, Emeline	JUN W	2005	UNAM UR- CSDY	16.23	
	6305	Ronveaux, Valentine	U23 W	2004	HELHa -CABW	DNF	

## Résultats : 110mH 1,067m - TC M

Tour : \*

- **Série : 1** **OFFICIEL** (16:33:36) Vent : +2.3 m/s

Pos.	Doss.	Athlète	Cat.	Année	Cercle	Perf.	Infos
1	5765	Obasuyi, Michael	SEN M	1999	OEH	13.35	
2	1082	Vancauwemberghe, Nolan	SEN M	2000	UCLou vainW- MOHA	13.89	
3	542	Debacker, Maxime	SEN M	2001	HELHa -OSGA	15.30	
4	1033	Riga, Hadrien	SEN M	2000	OPEN- FCHA	15.78	
5	1487	Stavart, Pierre	U23 M	2004	KU Leuven -CSDY	16.00	
6	4055	Convens, Tibo	JUN M	2005	KU Leuven -LOOI	16.59	

## Résultats : 200m - TC W

Tour : \*

- **Série : 1** **OFFICIEL** (17:17:08) Vent : +3.1 m/s

Pos.	Doss.	Athlète	Cat.	Année	Cercle	Perf.	Infos
1	6465	Duchene, Aurore	SEN W	2000	OPEN- CABW	25.00	

Pos.	Doss.	Athlète	Cat.	Année	Cercle	Perf.	Infos
2	1901	De Varé, Clara	U23 W	2004	KU Leuven -KAAG	25.20	
3	1406	Porton, Chloë	SEN W	2000	VUB- DCLA	25.63	
4	5083	Ponchione, Sara	JUN W	2006	AP- DAMP	25.83	
5	1509	De Troyer, Lisa	U23 W	2004	HOGE NT- LEBB	26.03	
6	6481	Cugnet-evans, Laureen°	SEN W	2000	OPEN- RCB	26.30	
7	6367	Cleymans, Emeline	SEN W	2001	UCLou vainW- SMAC	27.85	

• **Série : 2****OFFICIEL** (17:17:08)

Vent : +3.2 m/s

Pos.	Doss.	Athlète	Cat.	Année	Cercle	Perf.	Infos
1	6046	Bosquet, Aline°	SEN W	1999	ULB OWLS- CSF	25.49	
2	5267	Nsiala Kapinga Katanga, Christelle	JUN W	2005	UCLou vainW- CSF	25.58	
3	6376	Cooper, May Lee	SEN W	1998	ULiège Gx- CABW	25.60	
4	6380	Renkin, Emma	SEN W	1997	ULiège Lg- WACO	27.10	
5	6124	Penalver Garcia, Monica	SEN W	1999	HE Vinci- RCAS	27.44	
6	6126	sevrin, Laure°	SEN W	2001	AP- RCAS	27.55	
7	6208	Scheirlinckx, Chloé	SEN W	2001	UCLou vainW- RIWA	28.06	

• **Série : 3****OFFICIEL** (17:17:08)

Vent : +2.8 m/s

Pos.	Doss.	Athlète	Cat.	Année	Cercle	Perf.	Infos
1	6383	Lakhdar, Nassera	SEN W	2001	UCLou vainW- RCAS	27.15	
2	6117	Defosse, Maeva	SEN W	1998	UMON S- MOHA	28.19	
3	5002	Martin, Lucie	JUN W	2005	UCLou vainW- CSDY	28.98	

Pos.	Doss.	Athlète	Cat.	Année	Cercle	Perf.	Infos
4	6479	Huynh, Nathalie	SEN W	2001	UCLou vainW- RCB	29.80	
5	9936	Michel, Juliette	JUN W	2005	UCLou vainW- FRA	29.89	
6	6355	Alegre, Julia	U23 W	2003	ULiège Lg- HERV	30.02	
7	9940	Bachul, Ewa	SEN W	1999	UCLou vainW- NA	32.50	

## Résultats : 200m - TC M

Tour : \*

• **Série : 1**

**OFFICIEL** (17:17:30) Vent : +3.2 m/s

Pos.	Doss.	Athlète	Cat.	Année	Cercle	Perf.	Infos
1	885	Laurent, Luca	U23 M	2004	OPEN- SMAC	21.37	
2	5662	Heylen, Maarten	SEN M	1998	KU Leuven -AVLL	21.50	
3	1064	Nsangolo, Jean-Charles	SEN M	1996	OPEN- CSF	21.55	
4	671	Dehout, Floran	SEN M	2001	HELHa -CABW	21.62	
5	712	Jacques, Geoffrey	SEN M	2001	OPEN- SER	21.63	
6	5190	Van Den Bulcke, Jasper	U23 M	2003	UGent- LEBB	22.11	
7	1250	Léonard, Nicolas	SEN M	1999	OPEN- BBS	22.87	

• **Série : 2**

**OFFICIEL** (17:17:30) Vent : +2.4 m/s

Pos.	Doss.	Athlète	Cat.	Année	Cercle	Perf.	Infos
1	6017	van der Deure, Jelle°	U23 M	2002	KU Leuven -DCLA	22.55	
2	703	Loforte, Matéo	SEN M	2000	HELMo -SER	22.76	
3	1333	Scarniet, François	SEN M	1993	OPEN- ACLO	22.86	
4	952	Dumortier, Romain	SEN M	2001	ULiège Lg-SPA	23.18	
5	298	Schuermans, Adrien	JUN M	2005	AP-WS	23.30	
	254	Cimino, Gilles	JUN M	2005	HE Vinci- WS	DNS	Perf. Hom. :DNS



Pos.	Doss.	Athlète	Cat.	Année	Cercle	Perf.	Infos
	1080	Annet, Corentin	U23 M	2004	UCLou vainW- BBS	DNS	Perf. Hom. :DNS

- **Série : 3** **OFFICIEL** (17:17:30) Vent : +2.9 m/s

Pos.	Doss.	Athlète	Cat.	Année	Cercle	Perf.	Infos
1	4055	Convens, Tibo	JUN M	2005	KU Leuven -LOOI	23.10	
2	517	Scarniet, Nicolas	U23 M	2004	UCLou vainW- ACLO	23.35	
3	1180	Klein, Arnaud	SEN M	2001	ULB OWLS- CSF	23.50	
4	1079	Provoost, Noa	U23 M	2004	ULiège Lg- HERV	23.86	
5	687	Danno, Titouan	U23 M	2003	ULB OWLS- RCAS	24.27	
6	574	Hella, Guillaume	SEN M	1994	OPEN- WACO	24.29	
7	1262	Anani, Komi Daniel	SEN M	1999	EHB- CSF	24.82	

- **Série : 4** **OFFICIEL** (17:17:30) Vent : +1.7 m/s

Pos.	Doss.	Athlète	Cat.	Année	Cercle	Perf.	Infos
1	4148	De Rooze, Jurian	JUN M	2005	KU Leuven -DCLA	22.70	
2	1179	Bondue, Jason	SEN M	2001	ULB OWLS- CSF	22.96	
3	310	De Radigues, Thibaut	JUN M	2005	EPHEC -OCAN	24.68	
4	9955	Deramaix, Félix	JUN M	2005	UCLou vainW- NA	25.18	
5	9918	Pisetta, Antoine	U23 M	2004	UCLou vainW- NA	25.31	
6	9930	Hguiggach, Abdssamad	JUN M	2005	UCLou vainW- NA	25.91	
7	9931	Belle, Aurélien	U23 M	2002	HELHa -NA	27.82	

## Résultats : 5000m - TC M/W

Tour : \*

• **Série : 1****OFFICIEL** (17:44:17)

Pos.	Doss.	Athlète	Cat.	Année	Cercle	Perf.	Infos
1	1286	Michel, Maxime	SEN M	1992	OPEN-CSDY	15:10.30	
2	909	Pirnay, Julien	SEN M	2001	HEPL-FCHA	15:21.52	
3	9934	Fiessinger, Nicolas	SEN M	2000	UCLouvainW-FRA	15:38.41	
4	9902	Meurisse, Bastien	SEN M	2001	HEPHC-FRA	15:40.71	
5	5769	Simons, Wouter	SEN M	1996	PXL-ROBA	15:55.56	
6	5596	De Meulenaere, Brecht	SEN M	1993	OPEN-RIEM	16:17.35	
7	316	Erroyaux, Esteban	JUN M	2005	HELHa-USBW	16:33.89	
8	1352	Agrell, Oscar°	U23 M	2002	UCLouvainW-RIWA	16:38.29	
9	1488	Houis, Mathéo	SEN M	2000	UCLouvainW-CSDY	16:42.32	
10	9904	Coquer, Louan	SEN M	1999	UCLouvainW-FRA	17:04.00	
11	1132	Colot, Evariste	U23 M	2004	HELHa-FLEU	17:34.69	
12	3129	Miclotte, Isabel	W35	1986	OPEN-ASVO	19:21.23	
13	6482	Van Laeken, Lauryne	U23 W	2003	UCLouvainW-USBW	21:31.55	
	884	Lalmand, Donald	U23 M	2002	ICHEC-ECAM-CSF	DNF	
	976	Vancolen, Pierre	U23 M	2002	UCLouvainW-CSDY	DNF	
	6457	Vancolen, Elisa	SEN W	2001	UCLouvainW-CSDY	DNF	
	1505	Fayt, Karl	SEN M	2000	UCLouvainW-CSDY	DNF	
	765	Petitjean, Simon	SEN M	1996	UCLouvainW-RESC	DNF	

**Résultats : 3000m steeple 0,762m 28b - TC W****Tour : \***

- **Série : 1** **OFFICIEL** (18:04:15)

Pos.	Doss.	Athlète	Cat.	Année	Cercle	Perf.	Infos
1	1136	Spiessens, Jana	SEN W	2001	AP-SPBO	13:25.12	
2	9924	Baijot, Juliette	U23 W	2002	UCLouvainW-NA	13:58.01	

## Résultats : 3000m steeple 0,914m 28b - TC M

Tour : \*

- **Série : 1** **OFFICIEL** (18:05:36)

Pos.	Doss.	Athlète	Cat.	Année	Cercle	Perf.	Infos
1	5254	Verheyden, Tom	U23 M	2002	UGent-EA	10:27.21	
2	5769	Simons, Wouter	SEN M	1996	PXL-ROBA	11:23.16	
3	512	De Radigues, François	SEN M	2000	UCLouvainW-OCAN	11:36.72	
4	6834	Spiessens, Koen	M50	1971	OPEN-SPBO	12:48.67	
	661	Bassou, Adam	U23 M	2004	ULiège Lg-SER	DNS	

## Résultats : 4 x 100m - TC W

Tour : \*

- **Série : 1** **OFFICIEL** (18:22:39)

Pos.	Doss.	Athlète	Cat.	Année	Cercle	Perf.	Infos
1		UCLouvain Wolves 1			UCLouvainW-BBS	53.49	
2		UCLouvain Wolves 2			UCLouvainW-USTA	55.45	
3		UCL Wolfgang			NA	59.50	

## Résultats : 4 x 100m - TC M

Tour : \*

- **Série : 1** **OFFICIEL** (18:27:39)

Pos.	Doss.	Athlète	Cat.	Année	Cercle	Perf.	Infos
1		KU Leuven perchistes			KU Leuven-ROBA	45.78	

Pos.	Doss.	Athlète	Cat.	Année	Cercle	Perf.	Infos
2		UCLouvain Wolves			UCLouvainW-ACLO	47.43	
3		OPEN-OCAN			EPHEC-OCAN	48.20	

## Résultats : 4 x 400m - TC W

Tour : \*

- Aperçu total des résultats

## Résultats : 4 x 400m - TC M

Tour : \*

- Série : 1 **OFFICIEL** (18:39:33)

Pos.	Doss.	Athlète	Cat.	Année	Cercle	Perf.	Infos
1		UCL Staring wolves			UCLouvainW-WS	3:22.89	
2		UCLouvain Wolves 2			UCLouvainW-ACLO	3:40.85	
3		HEPHC-NA			HEPHC-NA	3:46.38	
4		OPEN-OCAN			ULiège Lg-OCAN	3:50.10	

## Résultats : 100 mètres D Finale

Tour : \*

- Série : 1 **OFFICIEL** (15:42:59) Vent : +2.4 m/s

Pos.	Doss.	Athlète	Cat.	Année	Cercle	Perf.	Infos
1	6108	Mortant, Alexandra	U23 W	2004	UCLouvainW-CABW	11.65	
2	6156	Morency Poilvache, Alizée	SEN W	1998	ULB OWLS-RESC	11.81	
3	1479	Beck, Lynn	SEN W	2001	KU Leuven-AVLL	11.98	
4	1545	Agwazie, Angel	SEN W	2001	ODISE E-OEH	11.99	
5	5267	Nsiala Kapinga Katanga, Christelle	JUN W	2005	UCLouvainW-CSF	12.36	



Pos.	Doss.	Athlète	Cat.	Année	Cercle	Perf.	Infos
4	711	Zgajewski, Mederic	SEN M	1999	UCLou vainW- ACLO	1m90	
5	1109	Van Kerm, Otis	SEN M	2001	UCLou vainW- BBS	1m80	
6	1314	Ngongo-Essomba, Jean-Paul	SEN M	1993	OPEN- CSF	1m70	

## Résultats : hauteur - TC W

Tour : \*

- **Groupe : 1** OFFICIEL (16:26:22)

Pos.	Doss.	Athlète	Cat.	Année	Cercle	Perf.	Infos
1	6373	Pardoms, Emilie	SEN W	2000	UCLou vainW- CABW	165m00	
2	6251	Braux, Lise	U23 W	2002	UCLou vainW- DAMP	160m00	
3	6317	Thiebot, Oceane	SEN W	2001	ULB OWLS- RESC	160m00	
4	5010	Theyskens, Cassandra	JUN W	2005	UCLou vainW- ACLO	155m00	
5	6455	Lane, Julie	U23 W	2003	UCLou vainW- CSDY	150m00	

## Résultats : longueur - TC M

Tour : \*

- **Groupe : 1** OFFICIEL (18:03:43)

Pos.	Doss.	Athlète	Cat.	Année	Cercle	Perf.	Infos
1	1298	Sampson, Yanni	U23 M	2004	HELMo -RFCL	7m28 +2.5m/s	
2	764	Nutte, Jean-Baptiste	SEN M	1998	OPEN- RESC	6m86 +1.4m/s	
3	335	Vandooren, Gatien	JUN M	2005	HE Vinci- JSMC	6m77 +2.3m/s	Perf. Hom. :6m71 (+0.9m/s)
4	1090	Claes, Melvyn	SEN M	2001	UCLou vainW- USTA	6m77 +3.5m/s	Perf. Hom. :6m75 (+1.9m/s)
5	532	Hervers, Florent	U23 M	2002	ULiège Lg- HERV	6m66 +2.2m/s	Perf. Hom. :6m59 (+1.9m/s)

Pos.	Doss.	Athlète	Cat.	Année	Cercle	Perf.	Infos
6	203	Pirotte, Clément	JUN M	2005	ULiège Lg- FCHA	6m56 +3.0m/s	Perf. Hom. :6m42 (+1.4m/s)
7	1029	Iker, Lucien	U23 M	2003	UCLou vainW- CABW	6m45 +1.4m/s	
8	1065	Guineberteau, Thibault	U23 M	2002	HE2B- CSF	6m20 +1.8m/s	
9	1458	Mabille, Robin	SEN M	1999	UCLou vainW- CSDY	5m70 +2.0m/s	
10	588	Lanier, Elouan°	SEN M	2001	HELB- CSF	5m67 +1.5m/s	
11	2225	Laus, Joachim	M35	1984	OPEN- ACBB	5m51 +2.7m/s	
	2302	Manzanza Kumbi, Hervé	M40	1983	OPEN- RCAS	DNS	

## Résultats : longueur - TC W

### Tour : \*

- **Groupe : 1** **OFFICIEL** (16:31:16)

Pos.	Doss.	Athlète	Cat.	Année	Cercle	Perf.	Infos
1	1520	Van Hoyweghen, Sara	U23 W	2003	UGent- VOLH	5m89 +1.2m/s	
2	6004	Vanhamme, Caroline	U23 W	2003	UCLou vainW- USTA	5m69 +1.8m/s	
3	6025	Buis, Noa	U23 W	2003	ULiège Lg- FCHA	5m60 +1.9m/s	
4	1700	Smets, Lotte	U23 W	2002	KU Leuven -ADD	5m20 +1.6m/s	
5	6330	De Sousa Moreira, Soraya°	SEN W	1999	HE Vinci- CSF	5m20 +1.5m/s	
6	6382	Jeanpierre, Lisa	U23 W	2004	ICHEC- ECAM- RCAS	5m08 +3.6m/s	Perf. Hom. :4m99 (+1.0m/s)
7	5011	Gomez-Mariné, Léa	JUN W	2005	ULiège Lg- HERV	5m04 +2.8m/s	Perf. Hom. :4m83 (+1.2m/s)
8	6198	Poot, Elise	U23 W	2002	UCLou vainW- USTA	4m97 +4.2m/s	Perf. Hom. :4m78 (+1.7m/s)
9	5215	Deschaux, Fleur	JUN W	2005	HE Vinci- RCB	4m73 +3.5m/s	
10	5045	Van Kerm, Selma	JUN W	2006	OPEN- ROCA	4m00 +2.9m/s	Perf. Hom. :3m89 (+2.0m/s)

## Résultats : triple - TC M

Tour : \*

- **Groupe : 1** OFFICIEL (16:12:58)

Pos.	Doss.	Athlète	Cat.	Année	Cercle	Perf.	Infos
1	1223	Soumahoro, Tommy	SEN M	1999	ULB OWLS-WS	13m60 -2.3m/s	
2	1500	Kempeneers, Sacha	SEN M	2000	ULiège Lg-HERV	13m11 -2.0m/s	
3	5461	Eyckmans, Fedde	U23 M	2003	KU Leuven -ABES	12m96 -1.1m/s	
4	1109	Van Kerm, Otis	SEN M	2001	UCLouvainW-BBS	12m90 -2.6m/s	
5	1212	Diame, Ismael	U23 M	2003	HE Vinci-USBW	12m72 -2.9m/s	

## Résultats : triple - TC W

Tour : \*

- **Groupe : 1** OFFICIEL (15:12:55)

Pos.	Doss.	Athlète	Cat.	Année	Cercle	Perf.	Infos
1	1401	Amon, Florence	SEN W	1999	EHB-DCLA	12m04 -2.5m/s	
2	5011	Gomez-Mariné, Léa	JUN W	2005	ULiège Lg-HERV	11m17 +1.6m/s	
	6345	Masson, Ilona	SEN W	2001	HEPL-FCHA	DNS	

## Résultats : perche - TC M

Tour : \*

- **Groupe : 1** OFFICIEL (19:02:46)

Pos.	Doss.	Athlète	Cat.	Année	Cercle	Perf.	Infos
1	133	Urbanczyk, Lukas	JUN M	2005	OPEN-MOHA	5m00	
2	842	Reip, Martin	U23 M	2003	HEPL-HF	4m70	
3	4358	Ginkels, Rune	JUN M	2005	KU Leuven -ROBA	4m60	
3	1030	Lanotte, Clément	SEN M	2001	EPHEC-DAMP	4m60	



Pos.	Doss.	Athlète	Cat.	Année	Cercle	Perf.	Infos
5	716	Gobin, Guillaume	SEN M	1999	HECH-SER	4m50	
6	134	Barthelemy, Jean-Lou	JUN M	2006	OPEN-MOHA	4m30	
7	5144	Degrande, Wout	U23 M	2004	KU Leuven-SPBO	4m10	
8	604	Deguella, Antonin	U23 M	2002	OPEN-SMAC	4m10	
9	632	Spigeleer, Loic	SEN M	2001	UCLouvainW-USBW	3m90	
10	972	Joannes, Loïc	SEN M	1994	ULiège Lg-CSDY	3m90	
11	6252	Van Hemelryck, Simon	U23 M	2003	KU Leuven-RCT	3m70	
12	1474	Muhadri, Samuel	U23 M	2003	HE Vinci-SMAC	3m50	
	538	Straet, Pierre	U23 M	2003	AP-HERV	NM	

## Résultats : perche - TC W

Tour : \*

• **Groupe : 1**

**OFFICIEL** (15:29:24)

Pos.	Doss.	Athlète	Cat.	Année	Cercle	Perf.	Infos
1	5172	Lepère, Lola	JUN W	2005	OPEN-RESC	4m10	
2	5169	Huybens, Clémence	JUN W	2005	UCLouvainW-CSDY	3m30	
3	6213	De Meue, Mathilde	SEN W	1998	UCLouvainW-CSDY	3m30	
4	6250	Bloch, Caroline	U23 W	2002	HEPL-HERV	3m30	
5	1548	Van Cappellen, Dag-Ferene	SEN W	2000	VUB-OEH	3m30	
6	6200	Van de Sype, Chloe	SEN W	1997	OPEN-RESC	3m20	
7	1936	Vanlangenaker, Charlotte	U23 W	2004	KU Leuven-ATLA	3m10	
8	5061	Moreau, Lilou	JUN W	2005	UCLouvainW-DAMP	2m95	

Pos.	Doss.	Athlète	Cat.	Année	Cercle	Perf.	Infos
9	6065	Lorge, Gaelle	U23 W	2003	UCLou vainW- SMAC	2m80	

## Résultats : disque 1,000kg - TC W

Tour : \*

- Groupe : 1** **OFFICIEL** (17:29:07)

Pos.	Doss.	Athlète	Cat.	Année	Cercle	Perf.	Infos
1	260	Tay, Sena	JUN W	2005	UGent- STAX	47m72	
2	6441	Nwanji, Joanne	SEN W	1999	UCLou vainW- SMAC	37m39	
3	5092	Scuttenaire, Clara	JUN W	2005	OPEN- CABW	34m97	
4	1936	Vanlangenaker, Charlotte	U23 W	2004	KU Leuven -ATLA	34m76	
5	1668	Oste, Helena	SEN W	2001	UGent- STAX	33m51	
6	84	Haenen, Yanah	JUN W	2005	THMO- GEEL	32m31	
7	6260	Ballas, Elsa	U23 W	2004	ULB OWLS- USBW	31m94	
8	5252	Flamand, Thais	JUN W	2006	OPEN- CSDY	27m60	
9	9950	Alves, Brenda	SEN W	2000	ULB OWLS- NA	24m56	
10	6200	Van de Sype, Chloe	SEN W	1997	OPEN- RESC	24m47	

## Résultats : javelot 600g - TC W

Tour : \*

- Groupe : 1** **OFFICIEL** (19:41:46)

Pos.	Doss.	Athlète	Cat.	Année	Cercle	Perf.	Infos
1	6004	Vanhamme, Caroline	U23 W	2003	UCLou vainW- USTA	41m45	
2	6154	Iven, Kayla	U23 W	2002	HE Vinci- RESC	39m78	
3	6304	Evans, Cassandre	SEN W	2001	OPEN- CABW	37m60	

Pos.	Doss.	Athlète	Cat.	Année	Cercle	Perf.	Infos
4	1520	Van Hoyweghen, Sara	U23 W	2003	UGent-VOLH	37m51	
5	6322	Clamar, Maud	SEN W	1999	OPEN-SER	36m68	
6	1700	Smets, Lotte	U23 W	2002	KU Leuven-ADD	36m21	
7	5064	Heinen, Lena	JUN W	2006	OPEN-HF	34m30	
8	6260	Ballas, Elsa	U23 W	2004	ULB OWLS-USBW	31m25	
9	5265	Serneels, Emeline	JUN W	2005	UNAM UR-CSDY	28m73	
10	84	Haenen, Yanah	JUN W	2005	THMO-GEEL	25m86	
11	6281	Ponlot, Célia	U23 W	2003	ULiège Lg-OCAN	24m22	
12	9942	Closset, Loriane	U23 W	2003	ULB OWLS-NA	15m43	
13	5005	Hoffer, Lucie	JUN W	2005	UCLouvainW-OCAN	15m34	
14	6397	Troussart, Noémie	U23 W	2003	HENAL LUX-ARCH	13m75	
	5287	Dekimpe, Lisandre	JUN W	2006	OPEN-JSMC	NM	

## Résultats : poids 7,260kg - TC M

Tour : \*

• **Groupe : 1**

**OFFICIEL** (15:04:53)

Pos.	Doss.	Athlète	Cat.	Année	Cercle	Perf.	Infos
1	5152	Stuyven, Pieter	U23 M	2004	ARTVE LDE-HAMM	15m64	
2	9901	Herraiz, Armand	SEN M	1996	UCLouvainW-FRA	15m40	
3	5575	Vander Schelde, Wietse	SEN M	2000	KU Leuven-TACT	14m43	
4	4011	Sefa, Jeffrey	JUN M	2006	STAX	12m50	
5	74	Delbushaye, Ethan	JUN M	2005	HEPL-HF	9m74	

Pos.	Doss.	Athlète	Cat.	Année	Cercle	Perf.	Infos
6	9925	Louis, Hadrien	U23 M	2002	HEPL-NA	8m14	

## Résultats : disque 2,000kg - TC M

Tour : \*

- Groupe : 1** OFFICIEL (16:04:52)

Pos.	Doss.	Athlète	Cat.	Année	Cercle	Perf.	Infos
1	5152	Stuyven, Pieter	U23 M	2004	ARTVE LDE-HAMM	45m84	
2	5575	Vander Schelde, Wietse	SEN M	2000	KU Leuven-TACT	42m02	
3	4191	Van Den Meersschaut, Ward	JUN M	2006	STAX	41m11	
4	764	Nutte, Jean-Baptiste	SEN M	1998	OPEN-RESC	38m72	
5	4011	Sefa, Jeffrey	JUN M	2006	STAX	34m51	
6	711	Zgajewski, Mederic	SEN M	1999	UCLou vainW-ACLO	34m47	
7	5437	Van Den Meersschaut, Arne	U23 M	2004	UGent-STAX	32m70	
8	874	Bodart, Arthur	U23 M	2003	UCLou vainW-BBS	31m82	
9	1474	Muhadri, Samuel	U23 M	2003	HE Vinci-SMAC	30m59	
10	604	Deguella, Antonin	U23 M	2002	OPEN-SMAC	28m15	
11	74	Delbushaye, Ethan	JUN M	2005	HEPL-HF	27m69	
12	512	De Radigues, François	SEN M	2000	UCLou vainW-OCAN	21m58	

## Résultats : javelot 800g - TC M

Tour : \*

- Groupe : 1** OFFICIEL (19:22:12)

Pos.	Doss.	Athlète	Cat.	Année	Cercle	Perf.	Infos
1	1108	Henry, Robin	SEN M	2001	UCLou vainW-BBS	60m88	
2	9932	Demortier, Robin	U23 M	2004	HECh-NA	54m43	

Pos.	Doss.	Athlète	Cat.	Année	Cercle	Perf.	Infos
3	521	Regaert, Simon	U23 M	2004	ULiège Lg- OCAN	49m31	
4	774	Masschaele, Arnaud	U23 M	2003	HENAL LUX- ARCH	38m87	
5	874	Bodart, Arthur	U23 M	2003	UCLou vainW- BBS	38m46	
6	1212	Diame, Ismael	U23 M	2003	HE Vinci- USBW	37m37	
7	9925	Louis, Hadrien	U23 M	2002	HEPL- NA	35m07	
8	1036	Vico, Tobias	U23 M	2003	ULB OWLS- MOHA	32m27	
9	8	Lefebvre, Tom	JUN M	2005	HEPL- OCAN	31m67	
10	9943	Serbes, Bradley	SEN M	2000	ULB OWLS- NA	27m71	
11	9947	Lequeux, Julien	U23 M	2002	ULB OWLS- NA	24m92	

## Résultats : poids 4,000kg - TC W

Tour : \*

- **Groupe : 1** **OFFICIEL** (15:36:31)

Pos.	Doss.	Athlète	Cat.	Année	Cercle	Perf.	Infos
1	6304	Evans, Cassandre	SEN W	2001	OPEN- CABW	12m74	
2	260	Tay, Sena	JUN W	2005	UGent- STAX	12m08	
3	5092	Scuttenaire, Clara	JUN W	2005	OPEN- CABW	11m11	
4	1668	Oste, Helena	SEN W	2001	UGent- STAX	9m81	
5	6117	Defosse, Maeva	SEN W	1998	UMON S- MOHA	9m21	
6	5005	Hoffer, Lucie	JUN W	2005	UCLou vainW- OCAN	7m77	
7	9945	Pisaneschi, Alessia	U23 W	2003	ULB OWLS- NA	7m54	
8	9942	Closset, Loriane	U23 W	2003	ULB OWLS- NA	7m28	



Pos.	Doss.	Athlète	Cat.	Année	Cercle	Perf.	Infos
9	9951	Vereycken, Noémie	SEN W	1998	ULB OWLS- NA	6m04	



# Résultats du Championnat FSUB de Badminton

UAntwerpen

Mercredi 13 décembre 2023



## Resultaten BSK badminton - 13/12/23 - Stadscampus Antwerpen



### Dames Enkel 1-2-3-4 - Hoofdschema

Naam	Onderwijsinstelling	Resultaat
Kira Destoop	KU Leuven	1
Mare Van Britsom	UGent	2
Lotte Geerts	VUB	3
Kaat Van Wouwe	VUB	4
Yseult Canautte	UCLouvain	5 tot 6
Evy Taveirne	UGent	5 tot 6

### Dames Enkel 5-6 - Hoofdschema

Naam	Onderwijsinstelling	Resultaat
Julie Van Hoof	Koninklijke Militaire school	1
Saskia Gekiere	UGent	2
Tess Vogelaere	UGent	3
Eleana Buchet	UCLouvain	4
Ana Isabel Veiga	KU Leuven	5 tot 6
Lindsey Wenzlawski	KDG hogeschool	5 tot 6
Erin Meskens	KU Leuven	WDN

### Heren Enkel 1-2-3-4 - Hoofdschema

Naam	Geslacht	Resultaat
Noa Swinnen	UGent	1
Wannes Soenen	UGent	2
Kilaïm Panggih Purwoko	KU Leuven	3
Milan Albers	UGent	4
Robbe Brees	Thomas More	5 tot 8
Jarne Daemers	HOGENT	5 tot 8
Seppe Mas	ULB	5 tot 8
Aaron Vandenberghe	KU Leuven	5 tot 8
Ramon Albers	UGent	9 tot 16
Quentin Bouchez	UGent	9 tot 16
Cyprien Cloutour	ULB	9 tot 16
Thomas Dufour	HELHa	9 tot 16
Jonathan Pijl	KU Leuven	9 tot 16
Hans Schroots	KU Leuven	9 tot 16
Michiel Van Britsom	UGent	9 tot 16
Elias Van Haevermaet	UGent	9 tot 16

### Heren Enkel 5-6 - Hoofdschema

Naam	Geslacht	Resultaat
------	----------	-----------



Luca Frere	ULB	1
Sander Ericx	KU Leuven	2
John Blot	UCLouvain	3
Luca Vandeput	KU Leuven	4
Mattias De Fraye	UCLL	5 tot 8
Martin Diederich-Amand	ULB	5 tot 8
Jiginni Sarvesh	KU Leuven	5 tot 8
Niel Swinnen	KU Leuven	5 tot 8
Milan De Angelis	UAntwerpen	9 tot 16
Sander Decubber	AP Hogeschool	9 tot 16
Wobbe Dermaux	KU Leuven	9 tot 16
Timon Hofmans	UAntwerpen	9 tot 16
Chao-Yuan Liu	KU Leuven	9 tot 16
Wout Maes	KU Leuven	9 tot 16
Diede Peeters	KU Leuven	9 tot 16
Rui Zhang	UGent	9 tot 16
Tomas Garcia Soler	KU Leuven	17

## Gemengd Dubbel 1-2-3-4 - Hoofdschema

Naam	Onderwijsinstelling	Naam	Onderwijsinstelling	Resultaat
Seppe Mas	ULB	Anaé Labarre	ULB	1
Wannes Soenen	UGent	Mare Van Bri	UGent	2
Kilaim Panggih Purwoko	KU Leuven	Kaat Van Wo	VUB	3
Quentin Bouchez	UGent	Evy Taveirne	UGent	4 tot 6
Michiel Van Britsom	UGent	Lotte Geerts	VUB	4 tot 6
Luca Vandeput	KU Leuven	Kira Destoop	KU Leuven	4 tot 6
John Blot	UCLouvain	Yseult Canau	UCLouvain	7 tot 9
Noa Swinnen	UGent	Lore Pooters	UGent	7 tot 9
Elias Van Haevermaet	UGent	Ine Van Wou	VUB	7 tot 9

## Gemengd Dubbel 5-6 - Hoofdschema

Naam	onderwijsinstelling	Naam2	Onderwijsinstelling	Resultaat
Hans Schroots	KU Leuven	Erin Mesken	KU Leuven	1
Jarne Daemers	HOGENT	Saskia Gekier	UGent	2
Ramon Albers	UGent	Tess Vogelae	UGent	3 tot 4
Aaron Vandenberghe	KU Leuven	Justine Vand	Arteveldeh	3 tot 4
Sander Decubber	AP hogeschool	Lindsey Wen	KDG Hoges	5 tot 6
Diede Peeters	KU Leuven	Julie Van Hoc	Koninklijke	5 tot 6
Yongcheng Liu	KU Leuven	Yongxu Yu	KU Leuven	7 tot 8
Wout Maes	KU Leuven	Ana Isabel Ve	KU Leuven	7 tot 8

# Résultats du Championnat FSUB de Course d'Orientation

Tihange

Dimanche 25 février 2024



# Résultats Course d'Orientation Forestière FSUB

## Dimanche 25/02/24

D:CU/BKU Women  4800m  170m (7)

					[H:]M:S	min/k m	
1.		<a href="#">Hannah THIELS</a>	BEL	D21	<a href="#">KU Leuven</a>	47:24	9'53"
2.		<a href="#">Laurence DEFRAIGNE</a>	BEL	D21	<a href="#">UCLouvain</a>	47:29	9'54" +0:05
3.		<a href="#">Marine SILLIEN</a>	BEL	D21	<a href="#">UCLouvain</a>	53:34	11'10" +6:10
4.		<a href="#">Gaëlle FRONHOFFS</a>	BEL	D21	<a href="#">Vrije Universiteit Brussel</a>	1:11:13	14'50" +23:49
5.		<a href="#">Emma FAUVILLON</a>	BEL	D21	<a href="#">Haute-école Louvain en Hainaut</a>	2:21:35	29'30" +1:34:11
6.		<a href="#">Eve BEAUJEAN</a>	BEL	D21	<a href="#">UCLouvain</a>	2:31:34	31'35" +1:44:10
7.		<a href="#">Léonie PFISTER</a>	BEL	D21	<a href="#">Haute-école Louvain en Hainaut</a>	2:39:08	33'09" +1:51:44

H:CU/BKU Men  6000m  210m (15)

						[H:]M:S	min/k m	
1.		<a href="#">Rune DE CLERCQ</a>	BEL	H-20	<a href="#">Universiteit Gent</a>	45:27	7'35"	
2.		<a href="#">Cédric AMERIJCKX</a>	BEL	H21	<a href="#">UCLouvain</a>	48:46	8'08" +3:19	
3.		<a href="#">Mathias INSTALLÉ</a>	BEL	H21	<a href="#">Haute-école Louvain en Hainaut</a>	1:04:32	10'45" +19:05	
4.		<a href="#">Victor MULLENS</a>	BEL	H-20	<a href="#">UCLouvain</a>	1:05:06	10'51" +19:39	
5.		<a href="#">Simon CHRISTIANE</a>	BEL	H-20	<a href="#">ULiège</a>	1:12:40	12'07" +27:13	
6.		<a href="#">Noam LEMY STORME</a>	BEL	H21	<a href="#">UCLouvain</a>	1:16:39	12'47" +31:12	
7.		<a href="#">Tibo GILLET</a>	BEL	H21	<a href="#">KU Leuven</a>	1:17:54	12'59" +32:27	
8.		<a href="#">Colin FERRIER</a>	BEL	H21	<a href="#">UCLouvain</a>	1:21:35	13'36" +36:08	
9.		<a href="#">Thomas VAN DYCK</a>	BEL	H21	<a href="#">UCLouvain</a>	1:39:38	16'36" +54:11	
10.		<a href="#">Jérôme BROSE</a>	BEL	H21	<a href="#">Haute Ecole Libre Mosane</a>	1:58:21	19'44" +1:12:54	
NCL		<a href="#">Adrien MORTIER</a>	BEL	H-20	<a href="#">Haute-école Louvain en Hainaut</a>			
NCL		<a href="#">Corneel CASIER</a>	BEL	H21	<a href="#">Universiteit Gent</a>			
NCL		<a href="#">Costa LUCCIONI</a>	BEL	H21	<a href="#">Haute-école Louvain en Hainaut</a>			
NCL		<a href="#">François DE RADIGUES</a>	BEL	H21	<a href="#">UCLouvain</a>			
NCL		<a href="#">John POSKIN</a>	BEL	H21	<a href="#">UCLouvain</a>			

# Résultats du Championnat FSUB de Course d'Orientation

Park Spoor Noord

(UAntwerpen)

Mardi 30 avril 2024









## BSK Urban Orienteering

### Park Spoor Noord Antwerpen – 30/04/24

#### Resultaten Dames











##### D:BK 4130m (6)

				[H:]M:S	min/km	
1.	 Marine SILLIEN	BEL	<a href="#">UCLouvain</a>	21:25	5'11"	
2.	 Sarah ROOMAN	BEL	<a href="#">KU Leuven</a>	22:22	5'25"	+0:57
3.	 Maya RENARD	BEL	<a href="#">KU Leuven</a>	23:31	5'42"	+2:06
4.	 Lotte TIESTERS	BEL	<a href="#">KU Leuven</a>	28:01	6'47"	+6:36
5.	 Julia KREKELS	BEL	<a href="#">KU Leuven</a>	29:35	7'10"	+8:10
6.	 Izabella PÓKA	HUN	<a href="#">Universiteit Antwerpen</a>	46:48	11'20"	+25:23

[Top](#)

#### Resultaten Heren

##### H:BK 4130m (9)

				[H:]M:S	min/km	
1.	 <a href="#">Corneel CASIER</a>	BEL	<a href="#">Universiteit Gent</a>	18:00	4'22"	
2.	 Rune DE CLERCQ 	BEL	<a href="#">Universiteit Gent</a>	18:07	4'23"	+0:07
3.	 Victor MULLENS	BEL	<a href="#">UCLouvain</a>	18:14	4'25"	+0:14
4.	 Martijn HUS	BEL	<a href="#">KU Leuven</a>	19:36	4'45"	+1:36
5.	 John POSKIN	BEL	<a href="#">UCLouvain</a>	21:57	5'19"	+3:57
6.	 Zijie NING	CHN	<a href="#">KU Leuven</a>	23:55	5'47"	+5:55
7.	 Silas TAPIA LAUWERS	BEL	<a href="#">Universiteit Antwerpen</a>	29:47	7'13"	+11:47
NCL	 François DE RADIGUES	BEL	<a href="#">UCLouvain</a>			
NCL	 Thomas VAN DYCK	BEL	<a href="#">UCLouvain</a>			

[Top](#)

Résultats du Championnat FSUB  
de Cross Country  
Braine l'Alleud  
Samedi 11 novembre 2023





Toitures Plasman - 48e G.P. Gaston Reiff de Cross-country - Braine-l'Alleud

## RESULTATS

Samedi 11 Novembre 2023

Parc du Cheneau

Braine-l'Alleud

Un grand merci à l'Administration Communale et à la Police de Braine l Alleud, à « Toitures Plasman » sponsor principal de l'évènement, à tous les sponsors de l'USBW, à tous les bénévoles sans qui l'organisation ne pourrait exister ainsi qu'à tous les athlètes présents.

Dank aan de Nederlandstalige clubs voor hun aanwezigheid en deelname



**Résultats : Cross Cadettes D**

Tour : \*

Cross Cadettes D

• **Série : 1****OFFICIEL** (13:58:49)

Pos.	Doss.	Athlète	Cat.	Année	Cercle	Perf.	Infos
1	8334	Geeraerts, Noémie	CAD F	2009	RIWA	5:14	
2	8367	Montois, Constance	CAD F	2009	USBW	5:14	
3	8125	Debroux, Ysia	CAD F	2009	CSF	5:26	
4	8646	Van Vyve, Yseult	CAD F	2009	CSDY	5:27	
5	8201	Rollier, Olivia	CAD F	2010	WS	5:28	
6	8254	Provoost, Elise	CAD F	2009	CABW	5:31	
7	8343	Degueldre, Vanille	CAD F	2009	CSDY	5:37	
8	8035	Wera, Caris	CAD F	2010	USBW	5:37	
9	8370	Richir Deville, Nina	CAD F	2009	CSF	5:38	
10	8495	Huyge, Manon	CAD F	2010	USBW	5:39	
11	8123	Debroux, Hanaé	CAD F	2010	CSF	5:40	
12	8365	Ba, Hapsa	CAD F	2010	WS	5:40	
13	8527	Manimaaran, Lila-Solenn°	CAD F	2010	CSF	5:47	
14	8389	Van Malleghem, Eva	CAD F	2009	CABW	5:48	
15	8126	Watine, Mathilde°	CAD F	2010	CSF	5:50	
16	8428	Engelbert, Maewenn	CAD F	2010	USBW	5:52	
17	8228	Doucet, Manon	CAD F	2010	CABW	6:02	
18		Blanchard, Nolwenn	CAD F	2010	CSDY	6:33	
19	200	Vanautgaerden, Suzan	CAD F	2010	ACP	6:49	
20	8535	Delellio, Lisa	CAD F	2009	USBW	7:12	
21	8648	Jouan, Elise	CAD F	2010	USBW	7:32	

**Résultats : Cross court D**

Tour : \*

Cross court D

• **Série : 1****OFFICIEL** (13:54:22)

Pos.	Doss.	Athlète	Cat.	Année	Cercle	Perf.	Infos
1	392	Laloux, Sophie (UCL Wolves)	SEN F	2000	NA	4:54	
2	6155	Joblin, Marine	SEN F	2002	RESC	4:55	
3	6129	Bruno, Fiona (HE Vinci)	SEN F	2001	OSGA	4:59	
4	6011	Collin, Amélie (HENALLUX)	SEN F	2001	UAC	5:08	
5	6356	Kouassi Aka, Oceane (ULB OWLS)	SEN F	2002	OSGA	5:13	
6	5123	Kägu, Gerta°	JUN F	2005	RESC	5:21	
7	5150	Lechat, Lucie (UCL Wolves)	JUN F	2005	ACLO	5:28	
8	6039	Godefridi, Isabelle	SEN F	1993	RIWA	5:30	
9	6350	Scutnaire, Léa (HE Condorcet)	SEN F	2004	OSGA	5:34	
10	1361	Dozinél, Lynn	SEN F	2001	OEH	5:39	
11	334	Evrard, Jeanne (He Vinci)	SEN F	2000	NA	5:42	



Pos.	Doss.	Athlète	Cat.	Année	Cercle	Perf.	Infos
12	5171	Louveaux, Delphine	JUN F	2005	CSDY	5:43	
13	340	Lybaert, Lola (He Vinci)	SEN F	2000	NA	5:43	
14	326	Burniaux, Clemence (HE Vinci)	SEN F	2000	NA	5:47	
15	6331	Heurckmans, Helen	SEN F	2003	CSF	5:54	
16	6212	Frahtia, Alia (UCL Wolves)	SEN F	2002	CSDY	5:55	
17	446	Verbrugge, Emma (UCL Wolves)	SEN F	2000	NA	5:56	
18	442	Tiberghien, Lilou (UCL Wolves)	SEN F	2000	NA	5:56	
19	6013	Balteau, Coline	SEN F	1998	FLEU	6:08	
20	5005	Hoffer, Lucie (UCL Wolves)	JUN F	2005	OCAN	6:15	
21	419	De Vinck, Olga (UCL Wolves)	SEN F	2000	NA	6:19	
22	438	Rossato, Letizia (UCL Wolves)	SEN F	2000	NA	6:20	
23	6211	Bertrand, Margaux (UCL Wolves)	SEN F	1997	CSDY	6:20	
24	342	Marsaud, Jeanne (He Vinci)	SEN F	2000	NA	6:21	
25	331	Decroes, Enya (He Vinci)	SEN F	2000	NA	6:23	
26	345	Vandekerkhove, Charlotte (He Vinci)	SEN F	2000	NA	6:26	
27	336	Geiregat, Florentine (He Vinci)	SEN F	2000	NA	6:35	
28	6145	Bouazzouz, Imane	SEN F	2001	WS	6:37	
29	341	Marion, Marilou (He Vinci)	SEN F	2000	NA	6:51	
30	439	Sneessens, Eve-Marie (HEH)	SEN F	2000	NA	6:54	
31	5144	Hauwaert, Abigaëlle	JUN F	2006	CSF	6:56	
32	328	Claerhout, Coline (He Vinci)	SEN F	2000	NA	6:57	
33	332	Delmeulle, Eve (He Vinci)	SEN F	2000	NA	7:14	
34	329	das Dores da Silva, Alice (He Vinci)	SEN F	2000	NA	7:17	
35	325	Bruls, Jasmine (He Vinci)	SEN F	2000	NA	7:19	
36	333	Dierickx, Gwenaëlle (He Vinci)	SEN F	2000	NA	7:20	
37	339	Lau, Josephine (He Vinci)	SEN F	2000	NA	7:22	
38	322	Benhalilem, Yusra (HE VINCI)	SEN F	2000	NA	7:33	
39	335	Facq, Auriane (He Vinci)	SEN F	2000	NA	7:38	
40	344	Poullier, Khelly (He Vinci)	SEN F	2000	NA	7:40	
41	321	Bailly, Ambre (HE VINCI)	SEN F	2000	NA	8:14	
42	337	Hoang, Anh-Christina (He Vinci)	SEN M	2000	NA	8:26	
43	327	Buys, Estelle (He Vinci)	SEN F	2000	NA	8:28	
44	324	Breitenstein, Finna (He Vinci)	SEN F	2000	NA	8:33	
45	338	Lahaye, Jasmine (He Vinci)	SEN F	2000	NA	8:56	
46	347	Zimmermann, Nina (He Vinci)	SEN F	2000	NA	9:05	
47	6006	Niedziela, Rosalia	SEN F	2003	ACLO	9:20	
48	330	Davreux, Alexandra (He Vinci)	SEN F	2000	NA	9:27	
49	7022	Servais, Isabelle	W45	1977	ACLO	9:55	

## Résultats : Cross court D ASEUS

Tour : \*

Cross court D ASEUS



Série : 1

OFFICIEL (10:22:34)

Pos.	Doss.	Athlète	Cat.	Année	Cercle	Perf.	Infos
1	392	Laloux, Sophie (UCL Wolves)	SEN F	2000	NA		
2	6129	Bruno, Fiona (HE Vinci)	SEN F	2001	OSGA		
3	6011	Collin, Amélie (HENALLUX)	SEN F	2001	UAC		
4	6356	Kouassi Aka, Oceane (ULB OWLS)	SEN F	2002	OSGA		
5	5150	Lechat, Lucie (UCL Wolves)	JUN F	2005	ACLO		
6	6350	Scutnaire, Léa (HE Condorcet)	SEN F	2004	OSGA		
7	334	Evrard, Jeanne (He Vinci)	SEN F	2000	NA		
8	340	Lybaert, Lola (He Vinci)	SEN F	2000	NA		
9	326	Burniaux, Clemence (HE Vinci)	SEN F	2000	NA		
10	6212	Frahtia, Alia (UCL Wolves)	SEN F	2002	CSDY		
11	446	Verbrugge, Emma (UCL Wolves)	SEN F	2000	NA		
12	442	Tiberghien, Lilou (UCL Wolves)	SEN F	2000	NA		
13	5005	Hoffer, Lucie (UCL Wolves)	JUN F	2005	OCAN		
14	419	De Vinck, Olga (UCL Wolves)	SEN F	2000	NA		
15	438	Rossato, Letizia (UCL Wolves)	SEN F	2000	NA		
16	6211	Bertrand, Margaux (UCL Wolves)	SEN F	1997	CSDY		
17	342	Marsaud, Jeanne (He Vinci)	SEN F	2000	NA		
18	331	Decroes, Enya (HE Vinci)	SEN F	2000	NA		
19	345	Vandekerkhove, Charlotte (He Vinci)	SEN F	2000	NA		
20	336	Geiregat, Florentine (HE Vinci)	SEN F	2000	NA		
21	341	Marion, Marilou (He Vinci)	SEN F	2000	NA		
22	439	Sneessens, Eve-Marie (HEH)	SEN F	2000	NA		
23	328	Claerhout, Coline (HE Vinci)	SEN F	2000	NA		
24	332	Delmeulle, Eve (HE Vinci)	SEN F	2000	NA		
25	329	das Dores da Silva, Alice (He Vinci)	SEN F	2000	NA		
26	325	Bruls, Jasmine (HE Vinci)	SEN F	2000	NA		
27	333	Dierickx, Gwenaëlle (He Vinci)	SEN F	2000	NA		
28	339	Lau, Josephine (He Vinci)	SEN F	2000	NA		
29	322	Benhalilem, Yousra (HE VINCI)	SEN F	2000	NA		
30	335	Facq, Auriane (HE Vinci)	SEN F	2000	NA		
31	344	Poullier, Khelly (He Vinci)	SEN F	2000	NA		
32	321	Bailly, Ambre (HE VINCI)	SEN F	2000	NA		
33	337	Hoang, Anh-Christina (He Vinci)	SEN M	2000	NA		
34	327	Buys, Estelle (HE Vinci)	SEN F	2000	NA		
35	324	Breitenstein, Finna (HE Vinci)	SEN F	2000	NA		
36	338	Lahaye, Jasmine (He Vinci)	SEN F	2000	NA		
37	347	Zimmermann, Nina (He Vinci)	SEN F	2000	NA		
38	330	Davreux, Alexandra (HE Vinci)	SEN F	2000	NA		

## Résultats : Cross Scolaires H

Tour : \*

Cross Scolaires H

• **Série : 1****OFFICIEL** (14:54:19)

Pos.	Doss.	Athlète	Cat.	Année	Cercle	Perf.	Infos
1	6481	Bourgeois, Oscar	SCO M	2007	ACTE	5:57	
2	6438	Janssens, Arthur	SCO M	2007	CABW	6:11	
3	80	De Coster, Tibo	SCO M	2007	ACP	6:12	
4	6547	Befayt, Anton	SCO M	2007	USBW	6:13	
5	6338	Lengelé, Arthur	SCO M	2007	OSGA	6:14	
6	6508	Vanschuytbroeck, Régis	SCO M	2007	CSDY	6:23	
7	6646	Bombaerts, Diego	SCO M	2007	CSDY	6:24	
8	6312	Roelandts, Pierrot	SCO M	2007	CSDY	6:24	
9	6553	Beauduin, Nathan	SCO M	2008	USBW	6:26	
10	139	Vandersteen, Siebe	SCO M	2008	ACP	6:29	
11	67	De Cremer, Siebe	SCO M	2008	ACP	6:32	
12	6377	Boucharlat, Basile°	SCO M	2007	CSF	6:34	
13	6426	Henriques De Granada, Nathanel	SCO M	2008	WS	6:41	
14	6339	Schollaert, Ulrich	SCO M	2007	OSGA	6:43	
15	683	Roelens, Twan	SCO M	2007	OEH	6:44	
16	6525	Wagret, Félix	SCO M	2007	OSGA	6:46	
17	6337	Lengele, Aurelien	SCO M	2008	OSGA	6:50	
18	402	Spits, Timo	SCO M	2008	OEH	6:56	
19	81	Janssens, Miel	SCO M	2007	ACP	6:57	
20	75	Leuckx, Xander	SCO M	2007	ACP	7:00	
21	82	Bruylandt, Kobe	SCO M	2008	ACP	7:00	
22	6636	Charlier, Luca	SCO M	2007	RESC	7:09	
23	6648	Kimyongur, Nidal	SCO M	2008	RESC	7:11	
24	462	Van Driessche, Louca	SCO M	2008	ACP	7:14	
25	6317	Carrez, Tom	SCO M	2008	USBW	7:19	
26	6436	Doyen, Samuel	SCO M	2008	CABW	7:35	
27	6539	Selleslagh, Arthur	SCO M	2008	CABW	7:51	

**Résultats : Cross court H ASEUS**

Tour : \*

Cross court H ASEUS

• **Série : 1****OFFICIEL** (10:42:54)

Pos.	Doss.	Athlète	Cat.	Année	Cercle	Perf.	Infos
1	567	Mullens, Victor (UCL Wolves)	SEN M	2004	HUY		
2	527	Belsack, Cyrill (HELHA)	SEN M	2004	CRAC		
3	1094	Lelievre, Thibault (UCL Wolves)	SEN M	2003	WS		
4	398	Oldenhove, Florent (UCL Wolves)	SEN M	2000	NA		
5	394	Leonard, Maxime (UCL Wolwes)	SEN M	2000	NA		
6	418	De Ridder, Matteo (HS Aertvelde)	SEN M	2000	NA		

Pos.	Doss.	Athlète	Cat.	Année	Cercle	Perf.	Infos
7	397	Heroufosse, Baptiste (UCL Wolves)	SEN M	2000	NA		
8	401	Jimenez Andrino, Carlos (HS Vives Zuid)	SEN M	2000	NA		
9	99	Jurion, Cyril (Uliège)	JUN M	2005	SPA		
10	404	Pistoresi, Dorian (ICHEC)	SEN M	2000	NA		
11	119	Salsanov, Tamirlan (HE2B)	JUN M	2005	USBW		
12	406	Albert, Florent (UCL Wolves)	SEN M	2000	NA		
13	819	Vanthournout, Camile (HELHA)	SEN M	2004	OSGA		
14	209	Blois, Cédric (HE2B)	JUN M	2005	OSGA		
15	350	Bombart, Jeremy (He Vinci)	SEN M	2000	NA		
16	421	Detollenaere, Maarten (KUL)	SEN M	2000	NA		
17	512	De Radigues, François (UCL Wolves)	SEN M	2000	OCAN		
18	377	Nachat, Mohamed (He Vinci)	SEN M	2000	NA		
19	365	Jaidi, Marouan (He Vinci)	SEN M	2000	NA		
20	387	Te Domange, Noah (He Vinci)	SEN M	2000	NA		
21	364	Iserentant, Basile (He Vinci)	SEN M	2000	NA		
22	417	De Neuville, Emmanuel (HS Gent)	SEN M	2000	NA		
23	359	Fernandes, Maxime (He Vinci)	SEN M	2000	NA		
24	386	Solagna, Nathan (He Vinci)	SEN M	2000	NA		
25	380	Polesello, Miles (He Vinci)	SEN M	2000	NA		
26	388	Van lede, Diego (He Vinci)	SEN M	2000	NA		
27	355	Dewandre, Noa (He Vinci)	SEN M	2000	NA		
28	353	Del Rio Marin, Antonio (He Vinci)	SEN M	2000	NA		
29	363	Holleville, Nicolas (He Vinci)	SEN M	2000	NA		
30	382	Rocha de Freitas, Hericky (He Vinci)	SEN M	2000	NA		
31	357	Dolhen, Thibaut (He Vinci)	SEN M	2000	NA		
32	428	Ismailovic, Sami (HENALLUX)	SEN M	2000	NA		
33	434	Manar, Anas (HENALLUX)	SEN M	2000	NA		
34	373	Masson, Julien (He Vinci)	SEN M	2000	NA		
35	390	Wolters, Louis (He Vinci)	SEN M	2000	NA		
36	354	Destrebecq, Isaias (He Vinci)	SEN M	2000	NA		
37	371	Marques-Coelho, Matéo (He Vinci)	SEN M	2000	NA		
38	348	Agustin , Niko (He Vinci)	SEN M	2000	NA		
39	360	Ferreira Almeida, Marco (He Vinci)	SEN M	2000	NA		
40	349	Belmehidi, Hamza (He Vinci)	SEN M	2000	NA		
41	367	Leonardo, Hugo Manuel (He Vinci)	SEN M	2000	NA		
42	383	Rosvort, David (He Vinci)	SEN M	2000	NA		
43	389	Van Parijs, Matteo (He Vinci)	SEN M	2000	NA		
44	385	Sobry, Pierre (He Vinci)	SEN M	2000	NA		
45	376	Muhadri, Driton (He Vinci)	SEN M	2000	NA		
46	368	Locicero, Romain (He Vinci)	SEN M	2000	NA		
47	379	Pak, Maxime (He Vinci)	SEN M	2000	NA		
48	352	Czerwinski, Valentin (He Vinci)	SEN M	2000	NA		

Pos.	Doss.	Athlète	Cat.	Année	Cercle	Perf.	Infos
49	372	Martin, Loan (He Vinci)	SEN M	2000	NA		
50	366	Keddad, Said (He Vinci)	SEN M	2000	NA		
51	369	Maene, Raphael (He Vinci)	SEN M	2000	NA		
52	375	Moermans, Jerome (he Vinci)	SEN M	2000	NA		
53	362	Herrewin, Ewan (He Vinci)	SEN M	2000	NA		
54	358	Eloy , Elyott (He Vinci)	SEN M	2000	NA		
55	361	Goffin, Cyril (He Vinci)	SEN M	2000	NA		

## Résultats : Cross court H

Tour : \*

Cross court H

• Série : 1

OFFICIEL (15:25:32)

Pos.	Doss.	Athlète	Cat.	Année	Cercle	Perf.	Infos
1	670	Debjani, Ismael	SEN M	1990	CABW	5:39	
2	139	Lelion, Achille	JUN M	2005	RESC	5:53	
3	43	Bossier, Hugo	JUN M	2005	CSF	5:55	
4	567	Mullens, Victor (UCL Wolves)	SEN M	2004	HUY	5:57	
5	527	Belsack, Cyrill (HELHA)	SEN M	2004	CRAC	5:58	
5	1141	Eon, Benjamin°	SEN M	1991	USTA	6:02	
6	1094	Lelievre, Thibault (UCL Wolves)	SEN M	2003	WS	5:59	
7	398	Oldenhove, Florent (UCL Wolves)	SEN M	2000	NA	6:01	
9	394	Leonard, Maxime (UCL Wolwes)	SEN M	2000	NA	6:05	
10	418	De Ridder, Matteo (HS Aertevelde)	SEN M	2000	NA	6:05	
11	1016	Sidali, Amir	SEN M	2001	WS	6:06	
12	397	Heroufousse, Baptiste (UCL Wolves)	SEN M	2000	NA	6:06	
13	917	Vanderstraeten, Kenzo	SEN M	2000	USBW	6:13	
14	6150	Allonsius, Jasper	SEN M	1991	OEH	6:13	
15	165	Courtois, Martin	JUN M	2006	USBW	6:15	
16	401	Jimenez Andrino, Carlos (HS Vives Zuid)	SEN M	2000	NA	6:20	
17	99	Jurion, Cyril (Uliège)	JUN M	2005	SPA	6:21	
18	104	Demol, Lucas	JUN M	2006	WS	6:23	
19	1081	De Groot, Dorian	SEN M	2001	CABW	6:27	
20	404	Pistoresi, Dorian (ICHEC)	SEN M	2000	NA	6:30	
21	1002	Hadj Abdallah, Glenn	SEN M	2000	CABW	6:30	
22	523	Solbreux, Antoine	SEN M	2001	USBW	6:30	
23	2460	Versmissen, Fabian	M35	1984	USBW	6:31	
24	119	Salsanov, Tamirlan (HE2B)	JUN M	2005	USBW	6:35	
25	2773	Cisse, Souleymane	M40	1979	RIWA	6:37	
26	833	Claus, Basile	SEN M	2004	USBW	6:39	
27	5073	Devillé, Jeroen	SEN M	1998	ACP	6:40	
28	2628	Benoit, Mathieu	M35	1985	CABW	6:42	

Pos.	Doss.	Athlète	Cat.	Année	Cercle	Perf.	Infos
29	4057	Carpentier, Bjarne	JUN M	2006	ACP	6:45	
30	406	Albert, Florent (UCL Wolves)	SEN M	2000	NA	6:48	
31	819	Vanthournout, Camile (HELHA)	SEN M	2004	OSGA	6:48	
32	1120	Pairoux, Alexandre	SEN M	1994	RIWA	6:50	
33	2337	Provoost, Erwin	M40	1978	CABW	6:52	
34	524	Solbreux, Thibaud	SEN M	2004	USBW	6:52	
35	2804	Xhonneux, Frederic	M40	1983	USBW	6:53	
36	160	Befayt, Yaël	JUN M	2005	USBW	6:56	
37	89	Verrier, Thibault	JUN M	2005	CABW	6:57	
38	1133	Ippoliti, Maxime	SEN M	1997	FLEU	6:57	
39	230	Mensah, Brice	JUN M	2005	RESC	6:58	
40	209	Blois, Cédric (HE2B)	JUN M	2005	OSGA	7:02	
41	350	Bombart, Jeremy (He Vinci)	SEN M	2000	NA	7:07	
42	2490	Tassignon, Thibault	M35	1984	RIWA	7:08	
43	421	Detollenaere, Maarten (KUL)	SEN M	2000	NA	7:18	
44	512	De Radigues, François (UCL Wolves)	SEN M	2000	OCAN	7:21	
45	2146	Lejeune, Christophe	M45	1977	RIWA	7:21	
46	377	Nachat, Mohamed (HE Vinci)	SEN M	2000	NA	7:24	
47	365	Jaidi, Marouan (He Vinci)	SEN M	2000	NA	7:27	
48	387	Te Domange, Noah (HE Vinci)	SEN M	2000	NA	7:29	
49	364	Iserentant, Basile (He Vinci)	SEN M	2000	NA		
50	417	De Neuville, Emmanuel (HS Gent)	SEN M	2000	NA		
51	359	Fernandes, Maxime (He Vinci)	SEN M	2000	NA		
52	386	Solagna, Nathan (HE Vinci)	SEN M	2000	NA		
53	380	Polesello, Miles (He Vinci)	SEN M	2000	NA		
54	2500	Vanwelde, Jean-François	M35	1987	USBW		
55	388	Van lede, Diego (HE Vinci)	SEN M	2000	NA		
56	355	Dewandre, Noa (He Vinci)	SEN M	2000	NA		
57	353	Del Rio Marin, Antonio (He Vinci)	SEN M	2000	NA		
58	363	Holleville, Nicolas (He Vinci)	SEN M	2000	NA		
59	382	Rocha de Freitas, Hericky (HE Vinci)	SEN M	2000	NA		
60	357	Dolhen, Thibaut (He Vinci)	SEN M	2000	NA		
61	428	Ismailovic, Sami (HENALLUX)	SEN M	2000	NA		
62	434	Manar, Anas (HENALLUX)	SEN M	2000	NA		
63	373	Masson, Julien (He Vinci)	SEN M	2000	NA		
64	390	Wolters, Louis (HE Vinci)	SEN M	2000	NA		
65	354	Destrebecq, Isaias (He Vinci)	SEN M	2000	NA		
66	371	Marques-Coelho, Matéo (He Vinci)	SEN M	2000	NA		
67	2837	Berckmans, Gilles	M45	1976	RIWA		
68	348	Agustin , Niko (He Vinci)	SEN M	2000	NA		
69	360	Ferreira Almeida, Marco (He Vinci)	SEN M	2000	NA		
70	349	Belmehidi, Hamza (He Vinci)	SEN M	2000	NA		

Pos.	Doss.	Athlète	Cat.	Année	Cercle	Perf.	Infos
71	367	Leonardo, Hugo Manuel (He Vinci)	SEN M	2000	NA		
72	383	Rosvort, David (HE Vinci)	SEN M	2000	NA		
73	389	Van Parijs, Matteo (HE Vinci)	SEN M	2000	NA		
74	385	Sobry, Pierre (HE Vinci)	SEN M	2000	NA		
75	376	Muhadri, Driton (HE Vinci)	SEN M	2000	NA		
76	368	Locicero, Romain (He Vinci)	SEN M	2000	NA		
77	379	Pak, Maxime (HE Vinci)	SEN M	2000	NA		
78	352	Czerwinski, Valentin (He Vinci)	SEN M	2000	NA		
79	372	Martin, Loan (He Vinci)	SEN M	2000	NA		
80	366	Keddad, Said (He Vinci)	SEN M	2000	NA		
81	369	Maene, Raphael (He Vinci)	SEN M	2000	NA		
82	375	Moermans, Jerome (he Vinci)	SEN M	2000	NA		
83	362	Herrewin, Ewan (He Vinci)	SEN M	2000	NA		
84	358	Eloy , Elyott (He Vinci)	SEN M	2000	NA		
85	361	Goffin, Cyril (He Vinci)	SEN M	2000	NA		

## Résultats : Cross Juniores D

Tour : \*

Cross Juniores D

- **Série : 1** **OFFICIEL** (15:35:43)

Pos.	Doss.	Athlète	Cat.	Année	Cercle	Perf.	Infos
1	5126	De Coninck, Maud	JUN F	2005	USBW	14:02	
2	5004	Parvais, Lilou	JUN F	2006	USBW	15:14	
3	5122	Vanthournout, Alys	JUN F	2006	OSGA	15:16	
4	5166	Collard, Fanny	JUN F	2006	USBW	16:23	
5	5137	Allard, Chloé	JUN F	2006	CABW	18:27	
6	346	Vogels, Eva (He Vinci)	SEN F	2000	NA	19:27	
7	5144	Hauwaert, Abigaëlle	JUN F	2006	CSF	20:27	

## Résultats : Cross Masters D

Tour : \*

Cross Masters D

- **Série : 1** **OFFICIEL** (15:39:25)

Pos.	Doss.	Athlète	Cat.	Année	Cercle	Perf.	Infos
1	3505	Van Den Driessche, Melissa	W35	1983	OEH	14:57	
2	7474	Desille, Nicole	W55	1967	FCHA	15:06	
3	7085	Cawet, Daphné	W40	1980	CSF	15:13	
4	3470	Degroote, Nele	W45	1978	OEH	16:16	
5	7316	Leroy, Camille <sup>^</sup>	W50	1973	WS	17:34	
6	3390	Landsheere, Christine	W55	1965	OEH	18:05	
7	7200	Ortiz Lanza, Maria Luisa <sup>°</sup>	W50	1973	CABW	18:31	



Pos.	Doss.	Athlète	Cat.	Année	Cercle	Perf.	Infos
8	3411	Hemmerijckx, Sara	W35	1984	OEH	19:07	
9	3208	Clement, Sandra	W50	1972	OEH	20:46	
10	3347	De Smedt, Anne-Marie	W65	1956	OEH	21:37	
11	7022	Servais, Isabelle	W45	1977	ACLO	24:37	

## Résultats : Cross Seniores D

Tour : \*

Cross Seniores D

• Série : 1

OFFICIEL (15:50:13)

Pos.	Doss.	Athlète	Cat.	Année	Cercle	Perf.	Infos
1	6271	Van den Abeele, Elodie	SEN F	1996	ACLO	19:05	
2	6261	Cleppe, Roxane	SEN F	2001	USBW	19:20	
3	6118	Grandjean, Lucie (UCL Wolves)	SEN F	2003	BBS	19:24	
4	402	Pauwelyn, Yana (KUL)	SEN F	2000	NA	19:41	
5	6138	Moulin, Marine (UCL Wolves)	SEN F	2000	BBS	20:33	
6	6298	Lombard, Maximilienne (ULB Owls)	SEN F	2003	OSGA	20:54	
7	400	Vancolen, Elisa (UCL Wolves)	SEN F	2000	NA	20:55	
8	395	Boniver, Alice (KUL)	SEN F	2000	NA	21:07	
9	6090	Lefevre, Eloise	SEN F	2004	SER	21:13	
10	6073	Arno, Lucie	SEN F	1999	ACTE	21:22	
11	6219	Goethals, Lutgard	SEN F	2002	RESC	21:26	
12	399	Sillien, Marine (UCL Wolves)	SEN F	2000	NA	21:46	
13	440	Suermont, Lily (HE Vinci)	SEN F	2000	NA	21:47	
14	1587	Rumers, Noor (KUL)	SEN F	2004	RCT	21:54	
15	6229	Gerebtzoff, Alice	SEN F	2002	CSF	21:58	
16	1596	Huylebroeck, Amy	SEN F	1999	OEH	22:08	
17	6285	Dieudonné, Delphine	SEN F	1992	CSF	22:12	
18	1807	Bernaerts, Soline	SEN F	1994	DAC	22:27	
19	5016	Lengelé, Alice (UMons)	JUN F	2005	OSGA	22:34	
20	6372	Bauwens, Marion	SEN F	1999	USBW	23:05	
21	441	Talpaert, Pauline (KUL)	SEN F	2000	NA	23:11	
22	444	Van Laeken, Lauryne (UCL Wolves)	SEN F	2000	NA	23:41	
23	1103	De Coster, Nina	SEN F	2003	ACP	23:45	
24	6264	Marchant, Lisa	SEN F	2003	CSF	24:42	
25	445	Vandewouwer, Marie (ICHEC)	SEN F	2000	NA	26:14	
26	1053	Leuckx, Kato	SEN F	2003	ACP	28:39	
27	425	Guillet, Olivia (HS West-VI)	SEN F	2000	NA	28:50	
28	416	De Geest, Marieke (HS Odisee)	SEN F	2000	NA	29:18	

## Résultats : Cross long D ASEUS

Tour : \*

Cross long D ASEUS



• **Série : 1****OFFICIEL** (10:50:27)

Pos.	Doss.	Athlète	Cat.	Année	Cercle	Perf.	Infos
1	6118	Grandjean, Lucie (UCL Wolves)	SEN F	2003	BBS		
2	402	Pauwelyn, Yana (KUL)	SEN F	2000	NA		
3	6138	Moulin, Marine (UCL Wolves)	SEN F	2000	BBS		
4	6298	Lombard, Maximilienne (ULB Owls)	SEN F	2003	OSGA		
5	400	Vancolen, Elisa (UCL Wolves)	SEN F	2000	NA		
6	395	Boniver, Alice (KUL)	SEN F	2000	NA		
7	399	Sillien, Marine (UCL Wolves)	SEN F	2000	NA		
8	440	Suermont, Lily (HE Vinci)	SEN F	2000	NA		
9	1587	Rumers, Noor (KUL)	SEN F	2004	RCT		
10	5016	Lengelé, Alice (UMons)	JUN F	2005	OSGA		
11	441	Talpaert, Pauline (KUL)	SEN F	2000	NA		
12	444	Van Laeken, Lauryne (UCL Wolves)	SEN F	2000	NA		
13	445	Vandewouwer, Marie (ICHEC)	SEN F	2000	NA		
14	425	Guillet, Olivia (HS West-VI)	SEN F	2000	NA		
15	416	De Geest, Marieke (HS Odisee)	SEN F	2000	NA		

**Résultats : Cross Juniors H****Tour : \***

Cross Juniors H

• **Série : 1****OFFICIEL** (16:47:32)

Pos.	Doss.	Athlète	Cat.	Année	Cercle	Perf.	Infos
1	112	Bourgeois, Louis	JUN M	2005	ACTE		
2	39	Vanmansart, Hugo	JUN M	2006	USBW		
3	144	Montois, Maxence	JUN M	2005	USBW		
4	205	Van Roye, Mano	JUN M	2006	USBW		
5	11	Vanderbruggen, Antoine	JUN M	2006	UAC		
6	156	Panepinto, Mirko	JUN M	2005	CABW		

**Résultats : Cross Seniors H****Tour : \***

Cross Seniors H

• **Série : 1****OFFICIEL** (11:13:19)

Pos.	Doss.	Athlète	Cat.	Année	Cercle	Perf.	Infos
1	919	D'Aurilio, Marvin	SEN M	1999	USBW		
2	509	Oldenhove, Martin (UCL Wolves)	SEN M	2003	CSDY		
3	5769	Simons, Wouter (HS PXL)	SEN M	1996	ROBA		
4	5447	Timmermans, Lode	SEN M	1998	ACP		
5	862	De Rijdt, Mathieu	SEN M	1993	USBW		
6	544	Lengelé, Antoine (UMons)	SEN M	2003	OSGA		
7	828	Poncelet, Valentin	SEN M	1991	USBW		

Pos.	Doss.	Athlète	Cat.	Année	Cercle	Perf.	Infos
8	830	Bouché, Romain	SEN M	2004	USBW		
9	9930	Demeuse, Clément	SEN M	1994	CSDY		
10	9922	Bourdon, Raphael	SEN M	2000	FRA		
11	705	Soudant, Nicolas	SEN M	1992	OSGA		
12	587	D'Aurilio, Simeon	SEN M	1996	CSF		
13	678	Hautefin, Silvain	SEN M	1995	CABW		
14	506	Houssiere, Pierre (UCL Wolwes)	SEN M	2002	CSDY		
15	736	Van Aerschot, Aurélien (HELHA)	SEN M	2001	ACTE		
16	846	Gillain, Pierre	SEN M	1998	CSDY		
17	5031	Vandeveld, Tim (UGent)	SEN M	2001	AZW		
18	1126	Petre, Maxime	SEN M	1989	RCB		
19	1143	Roeland, Loic	SEN M	1997	USBW		
20	639	Bourez, Robin	SEN M	2001	USBW		

## Résultats : Cross Masters H

Tour : \*

Cross Masters H

- **Série : 1** **OFFICIEL** (16:55:34)

Pos.	Doss.	Athlète	Cat.	Année	Cercle	Perf.	Infos
1	2344	Leblicq, Sebastien	M35	1985	CABW		
2	2749	Galerin, Denis	M35	1984	RIWA		
3	2573	Decamk, Francois	M35	1986	CABW		
4	6833	Vanautgaerden, Maarten	M45	1976	ACP		
5	2096	Bourdji, Sabri	M40	1982	OSGA		
6	2753	Calin, Thomas	M35	1984	CABW		
7	2459	Nyssen, Sebastien	M45	1978	USBW		
8	2554	Geens, Aart°	M35	1985	CSF		
9	7494	De Greef, Jeroen	M40	1979	OEH		
10	6701	Vanderstraeten, Patrick	M55	1964	ACP		
11	2705	Medici, Philippe	M55	1968	OSGA		
12	7809	Terrasse, Patrick	M45	1976	OEH		
13	7572	Stiens, Hans	M60	1962	OEH		
14	8016	Ebels, Jurriaan	M45	1974	ACP		
15	6809	Huybens, Dirk	M45	1976	ACP		
16	2146	Lejeune, Christophe	M45	1977	RIWA		
17	7344	Basteleus, Gunter	M50	1973	OEH		
18	2703	Lannoo, Michaël	M45	1975	CABW		
19	2372	El Kajjal, Mohamed	M55	1964	ACTE		
20	6759	Kerckhoven, Danny	M50	1971	ACP		
21	2802	Leroy, Marc	M55	1965	USBW		
22	2037	Groux, David	M45	1975	UAC		

Pos.	Doss.	Athlète	Cat.	Année	Cercle	Perf.	Infos
23	7025	Basteleus, Peter	M55	1966	OEH		
24	7433	De Brouwer, Bert	M50	1970	OEH		

## Résultats : Cross long H ASEUS

Tour : \*

Cross long H ASEUS

• Série : 1

OFFICIEL (11:22:55)

Pos.	Doss.	Athlète	Cat.	Année	Cercle	Perf.	Infos
1	423	Fiessinger, Nicolas (UCL Wolves)	SEN M	2000	NA		
2	403	Devuyt, Julien (HELHA)	SEN M	2000	NA		
3	509	Oldenhove, Martin (UCL Wolves)	SEN M	2003	CSDY		
4	5769	Simons, Wouter (HS PXL)	SEN M	1996	ROBA		
5	443	Van Camp, Siemen (KUL)	SEN M	2000	NA		
6	544	Lengelé, Antoine (UMons)	SEN M	2003	OSGA		
7	422	Erroyaux, Esteban (HELHA)	SEN M	2000	NA		
8	405	Agrell, Oscar (UCL Wolves)	SEN M	2000	NA		
9	432	Lechat, Antoine (UCL Wolves)	SEN M	2000	NA		
10	414	Coquer, Louan (UCL Wolves)	SEN M	2000	NA		
11	506	Houssiere, Pierre (UCL Wolves)	SEN M	2002	CSDY		
12	4312	Henot, Niel (KUL)	JUN M	2005	RCT		
13	736	Van Aerschot, Aurélien (HELHA)	SEN M	2001	ACTE		
14	429	Jacobs, Elias (KUL)	SEN M	2000	NA		
15	426	Guldentops, Hannes (ERM)	SEN M	2000	NA		
16	5031	Vandevelde, Tim (UGent)	SEN M	2001	AZW		
17	396	Clinquart, François (UCL Wolves)	SEN M	2000	NA		
18	408	Benouda, Nawfell (HE Vinci)	SEN F	2000	NA		
19	420	Deckers, Athanase (HEPL)	SEN M	2000	NA		
20	407	Bastien, Antoine (HEPL)	SEN M	2000	NA		
21	424	Fourreau, Julien (HEPL)	SEN M	2000	NA		
22	413	Buidin, Gaetan (HEH)	SEN M	2000	NA		
23	415	De Deurwaerder, Nicolas (HELHA)	SEN M	2000	NA		
24	7060	Liefsoens, Jeroen (HS PXL)	M40	1983	ACA		Classé 17ème en FSUB après vérification
25	435	Neyens, Damien (HE Vinci)	SEN M	2000	NA		

## Résultats : Scratch Jun-Sen-Mas H + ASEUS

Tour : \*

Scratch Jun-Sen-Mas H + ASEUS

• Série : 1

OFFICIEL (16:33:40)

Pos.	Doss.	Athlète	Cat.	Année	Cercle	Perf.	Infos
1	423	Fiessinger, Nicolas (UCL Wolves)	SEN M	2000	NA		
2	403	Devuyt, Julien (HELHA)	SEN M	2000	NA		

Pos.	Doss.	Athlète	Cat.	Année	Cercle	Perf.	Infos
3	919	D'Aurilio, Marvin	SEN M	1999	USBW		
4	509	Oldenhove, Martin (UCL Wolves)	SEN M	2003	CSDY		
5	5769	Simons, Wouter (HS PXL)	SEN M	1996	ROBA		
6	5447	Timmermans, Lode	SEN M	1998	ACP		
7	112	Bourgeois, Louis	JUN M	2005	ACTE		
8	443	Van Camp, Siemen (KUL)	SEN M	2000	NA		
9	2344	Leblicq, Sebastien	M35	1985	CABW		
10	862	De Rijdt, Mathieu	SEN M	1993	USBW		
11	2749	Galerin, Denis	M35	1984	RIWA		
12	544	Lengelé, Antoine (UMons)	SEN M	2003	OSGA		
13	422	Erroyaux, Esteban (HELHA)	SEN M	2000	NA		
14	828	Poncelet, Valentin	SEN M	1991	USBW		
15	830	Bouché, Romain	SEN M	2004	USBW		
16	9930	Demeuse, Clément	SEN M	1994	CSDY		
17	2573	Decamk, Francois	M35	1986	CABW		
18	9922	Bourdon, Raphael	SEN M	2000	FRA		
19	405	Agrell, Oscar (UCL Wolves)	SEN M	2000	NA		
20	432	Lechat, Antoine (UCL Wolves)	SEN M	2000	NA		
21	705	Soudant, Nicolas	SEN M	1992	OSGA		
22	6833	Vanautgaerden, Maarten	M45	1976	ACP		
23	414	Coquer, Louan (UCL Wolves)	SEN M	2000	NA		
24	587	D'Aurilio, Simeon	SEN M	1996	CSF		
25	678	Hautefin, Silvain	SEN M	1995	CABW		
26	39	Vanmansart, Hugo	JUN M	2006	USBW		
27	144	Montois, Maxence	JUN M	2005	USBW		
28	506	Houssiere, Pierre (UCL Wolves)	SEN M	2002	CSDY		
29	2096	Bourdji, Sabri	M40	1982	OSGA		
30	4312	Henot, Niel (KUL)	JUN M	2005	RCT		
31	736	Van Aerschot, Aurélien (HELHA)	SEN M	2001	ACTE		
32	846	Gillain, Pierre	SEN M	1998	CSDY		
33	205	Van Roye, Mano	JUN M	2006	USBW		
34	2753	Calin, Thomas	M35	1984	CABW		
35	429	Jacobs, Elias (KUL)	SEN M	2000	NA		
36	2459	Nyssen, Sebastien	M45	1978	USBW		
37	2554	Geens, Aart°	M35	1985	CSF		
38	426	Guldentops, Hannes (ERM)	SEN M	2000	NA		
39	5031	Vandevelde, Tim (UGent)	SEN M	2001	AZW		
40	1126	Petre, Maxime	SEN M	1989	RCB		
41	7494	De Greef, Jeroen	M40	1979	OEH		
42	6701	Vanderstraeten, Patrick	M55	1964	ACP		
43	11	Vanderbruggen, Antoine	JUN M	2006	UAC		
44	396	Clinquart, François (UCL Wolves)	SEN M	2000	NA		

Pos.	Doss.	Athlète	Cat.	Année	Cercle	Perf.	Infos
45	408	Benouda, Nawfell (HE Vinci)	SEN F	2000	NA		
46	420	Deckers, Athanase (HEPL)	SEN M	2000	NA		
47	407	Bastien, Antoine (HEPL)	SEN M	2000	NA		
48	424	Fourreau, Julien (HEPL)	SEN M	2000	NA		
49	2705	Medici, Philippe	M55	1968	OSGA		
50	156	Panepinto, Mirko	JUN M	2005	CABW		
51	7809	Terrasse, Patrick	M45	1976	OEH		
52	7572	Stiens, Hans	M60	1962	OEH		
53	8016	Ebels, Jurriaan	M45	1974	ACP		
54	6809	Huybens, Dirk	M45	1976	ACP		
55	2146	Lejeune, Christophe	M45	1977	RIWA		
56	413	Buidin, Gaetan (HEH)	SEN M	2000	NA		
57	1143	Roeland, Loic	SEN M	1997	USBW		
58	7344	Basteleus, Gunter	M50	1973	OEH		
59	2703	Lannoo, Michaël	M45	1975	CABW		
60	2372	El Kajjal, Mohamed	M55	1964	ACTE		
61	6759	Kerckhoven, Danny	M50	1971	ACP		
62	2802	Leroy, Marc	M55	1965	USBW		
63	415	De Deurwaerder, Nicolas (HELHA)	SEN M	2000	NA		
64	7060	Liefsoens, Jeroen (HS PXL)	M40	1983	ACA		
65	2037	Groux, David	M45	1975	UAC		
66	639	Bourez, Robin	SEN M	2001	USBW		
67	435	Neyens, Damien (HE Vinci)	SEN M	2000	NA		
68	7025	Basteleus, Peter	M55	1966	OEH		
69	7433	De Brouwer, Bert	M50	1970	OEH		

# Résultats du Championnat FSUB de Cyclisme Dames

Herne

Mardi 24 avril 2024





**BSK Wielrennen Dames**  
**24/04/24 - Herne**



Ranking algemeen klassement	Ranking studenten klassement	Naam/Name:	Voornaam/First name:	Instelling/Institution:
2	1	Van Mechelen	Gloria	KU Leuven
7	2	Theys	Hanna	UGENT
13	3	Huybrechts	Britt	Thomas More
14	4	Debouck	Elena	KU Leuven
17	5	Van Goethem	Femke	EHB
28	6	Janssen	Kaat	UGENT
33	7	Mahieu	Hannah	VIVES Hogeschool
35	8	Maes	Marie	UGENT
37	9	Van den Eede	Chloé	Odisee Sint-Niklaas
39	10	Brouckaert	Sophie	KU Leuven
42	11	Lenseclaes	Ditte	EHB
DNF	DNF	Goossaerts	Marieke	UGENT
DNF	DNF	De Mits	Maike	UGENT
DNF	DNF	Mariën	Ansofie	EHB
DNF	DNF	Van den broek	Aurely	KU Leuven
DNF	DNF	Ströker	Anaëlle	KU Leuven
DNF	DNF	Sas	Lore	UGENT
DNF	DNF	Poppe	Febe	VUB
DNF	DNF	Coenegrachts	Ella	UAntwerpen

Résultats du championnat FSUB d'Échecs  
Odisee Hogeschool (Campus Gent)  
Jeudi 14 mars 2024





# BK STUDENTEN

B.U.S.F. - F.S.U.B.



(©) FRBE 2005

PairTwo 4.14

Org. :

,2024

Tempo :

40c/2h + 1h QPF

Tie Break

Pts, Mutual Res, SonneBorn, Bucholtz

F.E.F.B.

 Studentensport  
Vlaanderen

R1 R2 R3 R4 R5 R6 R7

American Ranking

## Final Standing

Name	Rati	F/M	BirthDate	CLNr	Pts	Res	S	B	Buch	Onderwijsinstelling
1 Santamaria Fernandez G	(2184N)	M	20-04-1998	0	6.5/7	---	26.75	29.5		UMons
2 Magold Victor	( 0 )	M	12-12-2004	0	5.5/7	---	23.25	30.5		KU Leuven
3 Vanduyfhuys Daria	(2088N)	F	05-06-2003	0	5.0/7	2.0	21.50	33.0		Odisee Hogeschool
4 Van Dijck Bjarne	(2088N)	M	05-01-2001	0	5.0/7	2.0	19.50	31.5		UAntwerpen
5 Vanduyfhuys Igor	(2025N)	M	10-03-2006	0	5.0/7	---	18.50	27.5		UGent
6 Butzen Robin	(2059N)	M	13-02-2001	0	5.0/7	---	16.00	27.5		KU Leuven
7 Casterman Matis	( 0 )	M	05-09-2003	0	5.0/7	---	15.50	24.5		HEPH
8 Leyssens Bas	(1843N)	M	07-04-2000	0	4.0/7	2.0	13.00	28.5		AP Hogeschool
9 Temmerman Sara	(1774N)	F	16-04-1999	0	4.0/7	1.0	15.00	31.5		KU Leuven
10 De Baecke Jesse	( 0 )	M	05-06-2005	0	4.0/7	1.0	12.00	26.0		UAntwerpen
11 El Bachaoui Rayan	( 0 )	M	06-04-2003	0	4.0/7	---	14.50	30.0		KU Leuven
12 Debaere Thomas	(1653N)	M	30-04-2000	0	4.0/7	---	12.00	27.5		UGent
13 Vanbeselaere Victor	(1576N)	M	12-06-2002	0	4.0/7	---	10.00	23.0		UGent
14 De Keyser Renaat	( 0 )	M	16-12-2001	0	3.5/7	1.0	9.75	25.0		HOGENT
15 Vergauwen Bart	(1818N)	M	06-10-1972	0	3.5/7	0.5	9.75	25.5		Odisee Hogeschool
16 Smet Eduard	( 0 )	M	20-11-2004	0	3.5/7	0.5	6.75	18.5		Odisee Hogeschool
17 Pouliart Sander	(1497N)	M	24-10-1998	0	3.5/7	---	7.75	19.0		UAntwerpen
18 Cloetens Tibo	( 0 )	M	01-01-2000	0	3.0/7	1.0	9.00	26.5		UGent
19 Rycx Maarten	( 0 )	M	05-04-2000	0	3.0/7	1.0	6.00	22.5		UGent
20 De Cocq Ramin	(1881N)	M	21-07-2004	0	3.0/7	---	8.50	24.5		UAntwerpen
21 Dieleman Lucas	( 0 )	M		0	3.0/7	---	5.50	20.0		UGent
22 Van Huyck Robin	( 0 )	M	22-09-2003	0	2.5/7	1.0	7.75	24.5		UGent
23 Verschraegen Mats	( 0 )	M	11-05-2004	0	2.5/7	---	5.75	16.5		Odisee Hogeschool
24 Van Nimmen Lennert	( 0 )	M	20-06-2003	0	2.0/7	2.0	4.00	22.5		Odisee Hogeschool
25 De Batselier Tommie	( 0 )	M	08-03-2004	0	2.0/7	1.0	5.50	23.0		VIVES Hogeschool
26 Mercante Andrea	( 0 )	M	06-01-2003	0	2.0/7	1.0	4.50	21.0		HEPH
27 Masil Louis	( 0 )	M	19-07-2000	0	2.0/6	1.0	3.75	20.5		KU Leuven
28 Kovalenko Filip	( 0 )	M		0	2.0/7	1.0	2.50	15.0		UGent
29 Vandersnickt Simon	( 0 )	M	18-09-2001	0	2.0/7	---	1.75	18.5		UGent
30 Lopez Cava Cristina	( 0 )	F	11-06-1999	0	1.0/7	---	2.50	21.5		UMons
31 Gill Matthew	(1315N)	M	07-03-2004	0	0.0/0	---	12.25	24.5		UGent
32 Bastos Reinaldo Matteo	( 0 )	M	22-10-2002	0	0.0/0	---	12.25	24.5		ULB
33 Mirzale Zoleikha	( 0 )	F	18-04-1990	0	0.0/0	---	12.25	24.5		UHasselt
34 Pieters Reinout	( 0 )	M	04-05-2001	0	0.0/0	---	12.25	24.5		UGent
35 Sarkar Dipta	( 0 )	M	24-08-2001	0	0.0/0	---	12.25	24.5		Thomas More
36 Van De Walle Kian	( 0 )	M	14-06-2001	0	0.0/0	---	12.25	24.5		Odisee Hogeschool
37 Vandebussche Jakob	( 0 )	M	14-02-2000	0	0.0/0	---	12.25	24.5		KU Leuven
38 Walraevens Elisabeth	( 0 )	F	22-11-2003	0	0.0/0	---	12.25	24.5		Odisee Hogeschool
39 Steukers Daniel	( 0 )	M	19-03-2002	0	0.0/0	---	12.25	24.5		KU Leuven
40 Rotaru Teodor	( 0 )	M	26-05-1994	0	0.0/0	---	12.25	24.5		KU Leuven
41 Francesco Ngene	( 0 )	M	15-07-2002	0	0.0/0	---	12.25	24.5		ULB

### Round 1 (13-03-2024)

1	Lopez Cava Cristina	( 0 )( 1.0)	0-1	Santamaria Fernandez G(2184N)	( 6.5)
2	Vanduyfhuys Daria	(2088N)( 5.0)	1-0	Casterman Matis	( 0 )( 5.0)
3	Vandersnickt Simon	( 0 )( 2.0)	0-1	Van Dijck Bjarne	(2088N)( 5.0)
4	Butzen Robin	(2059N)( 5.0)	1-0	Van Huyck Robin	( 0 )( 2.5)
5	Cloetens Tibo	( 0 )( 3.0)	0-1	Vanduyfhuys Igor	(2025N)( 5.0)
6	De Cocq Ramin	(1881N)( 3.0)	0-1	Rycx Maarten	( 0 )( 3.0)
7	De Baecke Jesse	( 0 )( 4.0)	0-1	Leyssens Bas	(1843N)( 4.0)
8	Vergauwen Bart	(1818N)( 3.5)	1-0	Verschraegen Mats	( 0 )( 2.5)
9	El Bachaoui Rayan	( 0 )( 4.0)	0-1	Temmerman Sara	(1774N)( 4.0)
10	Debaere Thomas	(1653N)( 4.0)	1-0	Masil Louis	( 0 )( 2.0)
11	Van Nimmen Lennert	( 0 )( 2.0)	0-1	Vanbeselaere Victor	(1576N)( 4.0)
12	Pouliart Sander	(1497N)( 3.5)	0-1	Magold Victor	( 0 )( 5.5)
13	De Keyser Renaat	( 0 )( 3.5)	1-0	Dieleman Lucas	( 0 )( 3.0)
14	Mercante Andrea	( 0 )( 2.0)	0-1	Smet Eduard	( 0 )( 3.5)
15	De Batselier Tommie	( 0 )( 2.0)	1-0	Kovalenko Filip	( 0 )( 2.0)
	Bastos Reinaldo Matteo	( 0 )( 0.0)	Absent		
	Francesco Ngene	( 0 )( 0.0)	Absent		
	Gill Matthew	(1315N)( 0.0)	Absent		
	Mirzale Zoleikha	( 0 )( 0.0)	Absent		
	Pieters Reinout	( 0 )( 0.0)	Absent		
	Rotaru Teodor	( 0 )( 0.0)	Absent		
	Sarkar Dipta	( 0 )( 0.0)	Absent		
	Steukers Daniel	( 0 )( 0.0)	Absent		
	Van De Walle Kian	( 0 )( 0.0)	Absent		
	Vandenbussche Jakob	( 0 )( 0.0)	Absent		
	Walraevens Elisabeth	( 0 )( 0.0)	Absent		

[\(Go to Top\)](#)

### Round 2 (13-03-2024)

1	Santamaria Fernandez G(2184N)	( 6.5)	1-0	Temmerman Sara	(1774N)( 4.0)
2	Vanbeselaere Victor	(1576N)( 4.0)	0-1	Vanduyfhuys Daria	(2088N)( 5.0)
3	Van Dijck Bjarne	(2088N)( 5.0)	1-0	Debaere Thomas	(1653N)( 4.0)
4	Rycx Maarten	( 0 )( 3.0)	0-1	Butzen Robin	(2059N)( 5.0)
5	Vanduyfhuys Igor	(2025N)( 5.0)	1-0	De Keyser Renaat	( 0 )( 3.5)
6	Leyssens Bas	(1843N)( 4.0)	1-0	De Batselier Tommie	( 0 )( 2.0)
7	Magold Victor	( 0 )( 5.5)	1-0	Vergauwen Bart	(1818N)( 3.5)
8	Smet Eduard	( 0 )( 3.5)	0-1	De Cocq Ramin	(1881N)( 3.0)
9	Van Huyck Robin	( 0 )( 2.5)	1-0	Pouliart Sander	(1497N)( 3.5)
10	Dieleman Lucas	( 0 )( 3.0)	0-1	Cloetens Tibo	( 0 )( 3.0)
11	De Baecke Jesse	( 0 )( 4.0)	1-0	Mercante Andrea	( 0 )( 2.0)
12	Kovalenko Filip	( 0 )( 2.0)	0-1	El Bachaoui Rayan	( 0 )( 4.0)
13	Verschraegen Mats	( 0 )( 2.5)	0-1	Lopez Cava Cristina	( 0 )( 1.0)
14	Casterman Matis	( 0 )( 5.0)	1-0	Van Nimmen Lennert	( 0 )( 2.0)
15	Masil Louis	( 0 )( 2.0)	1-0	Vandersnickt Simon	( 0 )( 2.0)
	Bastos Reinaldo Matteo	( 0 )( 0.0)	Absent		
	Francesco Ngene	( 0 )( 0.0)	Absent		
	Gill Matthew	(1315N)( 0.0)	Absent		
	Mirzale Zoleikha	( 0 )( 0.0)	Absent		
	Pieters Reinout	( 0 )( 0.0)	Absent		
	Rotaru Teodor	( 0 )( 0.0)	Absent		
	Sarkar Dipta	( 0 )( 0.0)	Absent		
	Steukers Daniel	( 0 )( 0.0)	Absent		
	Van De Walle Kian	( 0 )( 0.0)	Absent		
	Vandenbussche Jakob	( 0 )( 0.0)	Absent		
	Walraevens Elisabeth	( 0 )( 0.0)	Absent		

[\(Go to Top\)](#)

### Round 3 (13-03-2024)

1	Butzen Robin	(2059N)( 5.0)	0-1	Santamaria Fernandez G	(2184N)( 6.5)
2	Vanduyfhuys Daria	(2088N)( 5.0)	1-0	Vanduyfhuys Igor	(2025N)( 5.0)
3	Leyssens Bas	(1843N)( 4.0)	0-1	Van Dijck Bjarne	(2088N)( 5.0)
4	Temmerman Sara	(1774N)( 4.0)	1-0	Magold Victor	( 0 )( 5.5)
5	De Cocq Ramin	(1881N)( 3.0)	0-1	De Baecke Jesse	( 0 )( 4.0)
6	Vergauwen Bart	(1818N)( 3.5)	1-0	Rycx Maarten	( 0 )( 3.0)
7	Debaere Thomas	(1653N)( 4.0)	1-0	Smet Eduard	( 0 )( 3.5)
8	Cloetens Tibo	( 0 )( 3.0)	0-1	Vanbeselaere Victor	(1576N)( 4.0)
9	Lopez Cava Cristina	( 0 )( 1.0)	0-1	Masil Louis	( 0 )( 2.0)
10	El Bachaoui Rayan	( 0 )( 4.0)	1-0	Casterman Matis	( 0 )( 5.0)
11	De Keyser Renaat	( 0 )( 3.5)	½-½	Van Huyck Robin	( 0 )( 2.5)
12	De Batselier Tommie	( 0 )( 2.0)	1-0	Pouliart Sander	(1497N)( 3.5)
13	Vandersnickt Simon	( 0 )( 2.0)	0-1	Dieleman Lucas	( 0 )( 3.0)
14	Mercante Andrea	( 0 )( 2.0)	1-0	Verschraegen Mats	( 0 )( 2.5)
15	Van Nimmen Lennert	( 0 )( 2.0)	1-0	Kovalenko Filip	( 0 )( 2.0)
	Bastos Reinaldo Matteo	( 0 )( 0.0)	Absent		
	Francesco Ngene	( 0 )( 0.0)	Absent		
	Gill Matthew	(1315N)( 0.0)	Absent		
	Mirzale Zoleikha	( 0 )( 0.0)	Absent		
	Pieters Reinout	( 0 )( 0.0)	Absent		
	Rotaru Teodor	( 0 )( 0.0)	Absent		
	Sarkar Dipta	( 0 )( 0.0)	Absent		
	Steukers Daniel	( 0 )( 0.0)	Absent		
	Van De Walle Kian	( 0 )( 0.0)	Absent		
	Vandenbussche Jakob	( 0 )( 0.0)	Absent		
	Walraevens Elisabeth	( 0 )( 0.0)	Absent		

[\(Go to Top\)](#)

### Round 4 (13-03-2024)

1	Santamaria Fernandez G	(2184N)( 6.5)	1-0	Vanduyfhuys Daria	(2088N)( 5.0)
2	Van Dijck Bjarne	(2088N)( 5.0)	1-0	Butzen Robin	(2059N)( 5.0)
3	Vanduyfhuys Igor	(2025N)( 5.0)	1-0	De Baecke Jesse	( 0 )( 4.0)
4	Vanbeselaere Victor	(1576N)( 4.0)	0-1	Leyssens Bas	(1843N)( 4.0)
5	Masil Louis	( 0 )( 2.0)	0-1	Vergauwen Bart	(1818N)( 3.5)
6	Temmerman Sara	(1774N)( 4.0)	1-0	De Batselier Tommie	( 0 )( 2.0)
7	Magold Victor	( 0 )( 5.5)	1-0	Debaere Thomas	(1653N)( 4.0)
8	Van Huyck Robin	( 0 )( 2.5)	0-1	El Bachaoui Rayan	( 0 )( 4.0)
9	Mercante Andrea	( 0 )( 2.0)	0-1	De Keyser Renaat	( 0 )( 3.5)
10	Casterman Matis	( 0 )( 5.0)	1-0	De Cocq Ramin	(1881N)( 3.0)
11	Dieleman Lucas	( 0 )( 3.0)	1-0	Van Nimmen Lennert	( 0 )( 2.0)
12	Rycx Maarten	( 0 )( 3.0)	1-0	Lopez Cava Cristina	( 0 )( 1.0)
13	Smet Eduard	( 0 )( 3.5)	0-1	Cloetens Tibo	( 0 )( 3.0)
14	Pouliart Sander	(1497N)( 3.5)	1-0	Vandersnickt Simon	( 0 )( 2.0)
15	Kovalenko Filip	( 0 )( 2.0)	0-1	Verschraegen Mats	( 0 )( 2.5)
	Bastos Reinaldo Matteo	( 0 )( 0.0)	Absent		
	Francesco Ngene	( 0 )( 0.0)	Absent		
	Gill Matthew	(1315N)( 0.0)	Absent		
	Mirzale Zoleikha	( 0 )( 0.0)	Absent		
	Pieters Reinout	( 0 )( 0.0)	Absent		
	Rotaru Teodor	( 0 )( 0.0)	Absent		
	Sarkar Dipta	( 0 )( 0.0)	Absent		
	Steukers Daniel	( 0 )( 0.0)	Absent		
	Van De Walle Kian	( 0 )( 0.0)	Absent		
	Vandenbussche Jakob	( 0 )( 0.0)	Absent		
	Walraevens Elisabeth	( 0 )( 0.0)	Absent		

[\(Go to Top\)](#)

### Round 5 (13-03-2024)

1	Van Dijck Bjarne	(2088N)( 5.0)	0-1	Santamaria Fernandez G	(2184N)( 6.5)
2	Vanduyfhuys Daria	(2088N)( 5.0)	1-0	Temmerman Sara	(1774N)( 4.0)
3	El Bachaoui Rayan	( 0 )( 4.0)	1-0	Vanduyfhuys Igor	(2025N)( 5.0)
4	Leyssens Bas	(1843N)( 4.0)	0-1	Magold Victor	( 0 )( 5.5)
5	Vergauwen Bart	(1818N)( 3.5)	0-1	De Keyser Renaat	( 0 )( 3.5)
6	Butzen Robin	(2059N)( 5.0)	1-0	Masil Louis	( 0 )( 2.0)
7	Debaere Thomas	(1653N)( 4.0)	1-0	Rycx Maarten	( 0 )( 3.0)
8	De Baecke Jesse	( 0 )( 4.0)	1-0	Vanbeselaere Victor	(1576N)( 4.0)
9	De Batselier Tommie	( 0 )( 2.0)	0-1	Dieleman Lucas	( 0 )( 3.0)
10	Cloetens Tibo	( 0 )( 3.0)	0-1	Casterman Matis	( 0 )( 5.0)
11	De Cocq Ramin	(1881N)( 3.0)	1-0	Van Huyck Robin	( 0 )( 2.5)
12	Verschraegen Mats	( 0 )( 2.5)	½-½	Pouliart Sander	(1497N)( 3.5)
13	Van Nimmen Lennert	( 0 )( 2.0)	1-0	Mercante Andrea	( 0 )( 2.0)
14	Lopez Cava Cristina	( 0 )( 1.0)	0-1	Smet Eduard	( 0 )( 3.5)
15	Vandersnickt Simon	( 0 )( 2.0)	0-1	Kovalenko Filip	( 0 )( 2.0)
	Bastos Reinaldo Matteo	( 0 )( 0.0)		Absent	
	Francesco Ngene	( 0 )( 0.0)		Absent	
	Gill Matthew	(1315N)( 0.0)		Absent	
	Mirzale Zoleikha	( 0 )( 0.0)		Absent	
	Pieters Reinout	( 0 )( 0.0)		Absent	
	Rotaru Teodor	( 0 )( 0.0)		Absent	
	Sarkar Dipta	( 0 )( 0.0)		Absent	
	Steukers Daniel	( 0 )( 0.0)		Absent	
	Van De Walle Kian	( 0 )( 0.0)		Absent	
	Vandenbussche Jakob	( 0 )( 0.0)		Absent	
	Walraevens Elisabeth	( 0 )( 0.0)		Absent	

[\(Go to Top\)](#)

### Round 6 (13-03-2024)

1	Santamaria Fernandez G	(2184N)( 6.5)	1-0	El Bachaoui Rayan	( 0 )( 4.0)
2	Magold Victor	( 0 )( 5.5)	1-0	Van Dijck Bjarne	(2088N)( 5.0)
3	De Keyser Renaat	( 0 )( 3.5)	0-1	Vanduyfhuys Daria	(2088N)( 5.0)
4	Temmerman Sara	(1774N)( 4.0)	0-1	Butzen Robin	(2059N)( 5.0)
5	Vanduyfhuys Igor	(2025N)( 5.0)	1-0	Debaere Thomas	(1653N)( 4.0)
6	Dieleman Lucas	( 0 )( 3.0)	0-1	Leyssens Bas	(1843N)( 4.0)
7	Casterman Matis	( 0 )( 5.0)	1-0	Vergauwen Bart	(1818N)( 3.5)
8	Rycx Maarten	( 0 )( 3.0)	0-1	De Baecke Jesse	( 0 )( 4.0)
9	Masil Louis	( 0 )( 2.0)	0-1	De Cocq Ramin	(1881N)( 3.0)
10	Vanbeselaere Victor	(1576N)( 4.0)	1-0	De Batselier Tommie	( 0 )( 2.0)
11	Smet Eduard	( 0 )( 3.5)	1-0	Van Nimmen Lennert	( 0 )( 2.0)
12	Pouliart Sander	(1497N)( 3.5)	1-0	Cloetens Tibo	( 0 )( 3.0)
13	Van Huyck Robin	( 0 )( 2.5)	1-0	Verschraegen Mats	( 0 )( 2.5)
14	Kovalenko Filip	( 0 )( 2.0)	0-1	Mercante Andrea	( 0 )( 2.0)
15	Vandersnickt Simon	( 0 )( 2.0)	1-0	Lopez Cava Cristina	( 0 )( 1.0)
	Bastos Reinaldo Matteo	( 0 )( 0.0)		Absent	
	Francesco Ngene	( 0 )( 0.0)		Absent	
	Gill Matthew	(1315N)( 0.0)		Absent	
	Mirzale Zoleikha	( 0 )( 0.0)		Absent	
	Pieters Reinout	( 0 )( 0.0)		Absent	
	Rotaru Teodor	( 0 )( 0.0)		Absent	
	Sarkar Dipta	( 0 )( 0.0)		Absent	
	Steukers Daniel	( 0 )( 0.0)		Absent	
	Van De Walle Kian	( 0 )( 0.0)		Absent	
	Vandenbussche Jakob	( 0 )( 0.0)		Absent	
	Walraevens Elisabeth	( 0 )( 0.0)		Absent	

[\(Go to Top\)](#)



Round 7 (13-03-2024)					
1	Magold Victor	( 0 )( 5.5)	½-½	Santamaria Fernandez G(2184N)	( 6.5)
2	Vanduyfhuys Daria	(2088N)( 5.0)	0-1	Van Dijck Bjarne	(2088N)( 5.0)
3	Butzen Robin	(2059N)( 5.0)	1-0	El Bachaoui Rayan	( 0 )( 4.0)
4	Leyssens Bas	(1843N)( 4.0)	0-1	Vanduyfhuys Igor	(2025N)( 5.0)
5	De Baecke Jesse	( 0 )( 4.0)	0-1	Casterman Matis	( 0 )( 5.0)
6	De Keyser Renaat	( 0 )( 3.5)	0-1	Temmerman Sara	(1774N)( 4.0)
7	De Cocq Ramin	(1881N)( 3.0)	0-1	Vanbeselaere Victor	(1576N)( 4.0)
8	Vergauwen Bart	(1818N)( 3.5)	½-½	Smet Eduard	( 0 )( 3.5)
9	Debaere Thomas	(1653N)( 4.0)	1-0	Dieleman Lucas	( 0 )( 3.0)
10	Mercante Andrea	( 0 )( 2.0)	0-1	Pouliart Sander	(1497N)( 3.5)
11	Cloetens Tibo	( 0 )( 3.0)	1-0	Van Huyck Robin	( 0 )( 2.5)
12	Van Nimmen Lennert	( 0 )( 2.0)	0-1	Rycx Maarten	( 0 )( 3.0)
13	Verschraegen Mats	( 0 )( 2.5)	1-0	De Batselier Tommie	( 0 )( 2.0)
14	Lopez Cava Cristina	( 0 )( 1.0)	0-1	Kovalenko Filip	( 0 )( 2.0)
15	Vandersnickt Simon	( 0 )( 2.0)	Bye		
	Bastos Reinaldo Matteo	( 0 )( 0.0)	Absent		
	Francesco Ngene	( 0 )( 0.0)	Absent		
	Gill Matthew	(1315N)( 0.0)	Absent		
	Masil Louis	( 0 )( 2.0)	Absent		
	Mirzale Zoleikha	( 0 )( 0.0)	Absent		
	Pieters Reinout	( 0 )( 0.0)	Absent		
	Rotaru Teodor	( 0 )( 0.0)	Absent		
	Sarkar Dipta	( 0 )( 0.0)	Absent		
	Steukers Daniel	( 0 )( 0.0)	Absent		
	Van De Walle Kian	( 0 )( 0.0)	Absent		
	Vandenbussche Jakob	( 0 )( 0.0)	Absent		
	Walraevens Elisabeth	( 0 )( 0.0)	Absent		

[\(Go to Top\)](#)

American Ranking														
	Name	Rating	Pts	Perf	R1	R2	R3	R4	R5	R6	R7	Res	S B	Buch
1	Santamaria Fernandez Guillermo	2184	6.5	2360	30B +	9W +	6B +	3W +	4B +	11W +	2B =	---	26.75	29.5
2	Magold Victor	0	5.5	2066	17B +	15W +	9B -	12W +	8B +	4W +	1W =	---	23.25	30.5
3	Vanduyfhuys Daria	2088	5.0	2063	7W +	13B +	5W +	1B -	9W +	14B +	4W -	2.0	21.50	33.0
4	Van Dijck Bjarne	2088	5.0	2078	29B +	12W +	8B +	6W +	1W -	2B -	3B +	2.0	19.50	31.5
5	Vanduyfhuys Igor	2025	5.0	1924	18B +	14W +	3B -	10W +	11B -	12W +	8B +	---	18.50	27.5
6	Butzen Robin	2059	5.0	2006	22W +	19B +	1W -	4B -	27W +	9B +	11W +	---	16.00	27.5
7	Casterman Matis	0	5.0	992	3B -	24W +	11B -	20W +	18B +	15W +	10B +	---	15.50	24.5
8	Leyssens Bas	1843	4.0	1715	10B +	25W +	4W -	13B +	2W -	21B +	5W -	2.0	13.00	28.5
9	Temmerman Sara	1774	4.0	1759	11B +	1B -	2W +	25W +	3B -	6W -	14B +	1.0	15.00	31.5
10	De Baecke Jesse	0	4.0	1096	8W -	26W +	20B +	5B -	13W +	19B +	7W -	1.0	12.00	26.0
11	El Bachaoui Rayan	0	4.0	1198	9W -	28B +	7W +	22B +	5W +	1B -	6B -	---	14.50	30.0
12	Debaere Thomas	1653	4.0	1553	27W +	4B -	16W +	2B -	19W +	5B -	21W +	---	12.00	27.5
13	Vanbeselaere Victor	1576	4.0	1557	24B +	3W -	18B +	8W -	10B -	25W +	20B +	---	10.00	23.0
14	De Keyser Renaat	0	3.5	1100	21W +	5B -	22W =	26B +	15B +	3W -	9W -	1.0	9.75	25.0
15	Vergauwen Bart	1818	3.5	1468	23W +	2B -	19W +	27B +	14W -	7B -	16W =	0.5	9.75	25.5
16	Smet Eduard	0	3.5	764	26B +	20W -	12B -	18W -	30B +	24W +	15B =	0.5	6.75	18.5
17	Pouliart Sander	1497	3.5	1147	2W -	22B -	25B -	29W +	23B =	18W +	26B +	---	7.75	19.0
18	Cloetens Tibo	0	3.0	678	5W -	21B +	13W -	16B +	7W -	17B -	22W +	1.0	9.00	26.5
19	Rycx Maarten	0	3.0	1008	20B +	6W -	15B -	30W +	12B -	10W -	24B +	1.0	6.00	22.5
20	De Cocq Ramin	1881	3.0	1487	19W -	16B +	10W -	7B -	22W +	27B +	13W -	---	8.50	24.5
21	Dieleman Lucas	0	3.0	449	14B -	18W -	29B +	24W +	25B +	8W -	12B -	---	5.50	20.0
22	Van Huyck Robin	0	2.5	674	6B -	17W +	14B =	11W -	20B -	23W +	18B -	1.0	7.75	24.5
23	Verschraegen Mats	0	2.5	371	15B -	30W -	26B -	28B +	17W =	22B -	25W +	---	5.75	16.5
24	Van Nimmen Lennert	0	2.0	67	13W -	7B -	28W +	21B -	26W +	16B -	19W -	2.0	4.00	22.5
25	De Batselier Tommie	0	2.0	797	28W +	8B -	17W +	9B -	21W -	13B -	23B -	1.0	5.50	23.0
26	Mercante Andrea	0	2.0	55	16W -	10B -	23W +	14W -	24B -	28B +	17W -	1.0	4.50	21.0
27	Masil Louis	0	2.0	1118	12B -	29W +	30B +	15W -	6B -	20W -	...	1.0	3.75	20.5
28	Kovalenko Filip	0	2.0	-158	25B -	11W -	24B -	23W -	29B +	26W -	30B +	1.0	2.50	15.0
29	Vandersnickt Simon	0	2.0	324	4W -	27B -	21W -	17B -	28W -	30W +	bye	---	1.75	18.5
30	Lopez Cava Cristina	0	1.0	16	1W -	23B +	27W -	19B -	16W -	29B -	28W -	---	2.50	21.5
31	Gill Matthew	1315	0.0	0	...	...	...	...	...	...	...	---	12.25	24.5
32	Bastos Reinaldo Matteo	0	0.0	0	...	...	...	...	...	...	...	---	12.25	24.5
33	Mirzale Zoleikha	0	0.0	0	...	...	...	...	...	...	...	---	12.25	24.5
34	Pieters Reinout	0	0.0	0	...	...	...	...	...	...	...	---	12.25	24.5
35	Sarkar Dipta	0	0.0	0	...	...	...	...	...	...	...	---	12.25	24.5
36	Van De Walle Kian	0	0.0	0	...	...	...	...	...	...	...	---	12.25	24.5
37	Vandenbussche Jakob	0	0.0	0	...	...	...	...	...	...	...	---	12.25	24.5
38	Walraevens Elisabeth	0	0.0	0	...	...	...	...	...	...	...	---	12.25	24.5
39	Steukers Daniel	0	0.0	0	...	...	...	...	...	...	...	---	12.25	24.5
40	Rotaru Teodor	0	0.0	0	...	...	...	...	...	...	...	---	12.25	24.5
41	Francesco Ngene	0	0.0	0	...	...	...	...	...	...	...	---	12.25	24.5

# Résultats du championnat FSUB d'Echecs

“ONLINE”

UAntwerpen

17/10/2023



**BSK Schaken Blitz (online) / Championnat FSUB Echecs Blitz (online) 2023-24**  
**17/10/2023 - lichess.org**

#	family name	name	institution	lichess	R1	R2	R3	R4	R5	R6	R7	R8	R9	points	Tie-Break
1	Van Volsem	Merlijn	UGent	MerlinTheWizard13	1	1	1	1	½	1	1	1	1	8,5	46,25
2	Victor	Magold	KU Leuven	monigatora	1	1	1	1	1	0	1	1	0	7	38,5
3	Pouley	Floris	UGent	flor12	1	1	1	0	0	1	1	1	1	7	35
4	Rotaru	Teodor	KU Leuven	teo2605	1	1	1	1	0	0	1	1	1	7	32,5
5	Dreelinck	Adriaan	UGent	Bluffalo	1	1	1	1	½	1	0	0	1	6,5	40,25
6	Van Dijk	Bjarne	UAntwerpen	gmdrizzlydrake	1	0	1	1	1	1	0	0	1	6	32
7	Tsouptsis	Sotirios	KU Leuven	s0ts	1	1	1	0	1	0	1	1	0	6	31
8	Tanghe	Tobias	Odisee Hogeschool	toto639	1	1	0	1	1	0	0	1	1	6	29
9	Tshilolo	Josémaria	ULiège	i_m_not_the_one2	1	0	0	1	1	1	1	1	0	6	28,5
10	Leitner	Lukas	UAntwerpen	Luktuktuk	1	1	0	1	1	1	1	0	0	6	28
11	Hoskens	Ruben	UAntwerpen	Bloedweust	0	1	0	1	1	1	1	0	1	6	28
12	Bernaert	Mathieu	UGent	mbBest	0	1	1	1	1	0	0	1	1	6	26,5
13	Rus	Călin-Ioan	UHasselt	clnrs	1	0	1	1	0	½	1	½	1	6	26,25
14	Meersman	Nicolas	KU Leuven	Nicolas191	1	1	0	1	0	1	0	1	1	6	24
15	Boly	Tom	HELHa	Tomandco	1	0	1	0	1	0	1	1	1	6	22
16	Rechouk	Yasser	LUCA	L1zardK1ng	½	1	0	1	0	1	1	1	0	5,5	23,5
17	Nguyen	Anh-Tuan	UAntwerpen	antuan299	1	0	1	1	1	1	0	0	0	5	24
18	De Batselier	Tommie	VIVES Zuid	Chronos6660	½	1	0	1	0	1	1	½	0	5	22,75
19	Debaere	Thomas	UGent	Deljeipn	1	0	1	1	0	1	1	0	0	5	21,5
20	Van Ham	Jozef	UAntwerpen	Jefvanham	1	0	0	1	1	0	1	1	0	5	20
21	Smet	Eduard	Odisee Hogeschool	Celarye	1	0	1	0	0	0	1	1	1	5	20
22	Pouliart	Sander	UAntwerpen	Thesapo98	1	1	0	1	0	1	0	1	0	5	19,5
23	santens heyndrickx	thibault	ERM	passetempskms	1	0	1	0	0	1	1	0	1	5	18
24	Eerdekens	Rune	HOGENT	Frosty457	0	1	0	1	0	1	0	1	1	5	17
25	Vanbeselaere	Victor	UGent	victorvb	0	0	½	½	1	1	0	1	1	5	16,75
26	Hatipoglu	Ahmet	KU Leuven	Hatip2003	1	0	1	0	1	0	0	1	1	5	15,5
27	Steukers	Daniel	KU Leuven	Sausagjs	1	1	0	0	0	½	1	0	1	4,5	16
28	Pijlijser	Ilian	UGent	IlianPi	0	0	1	1	1	½	0	1	0	4,5	13,5
29	Vandamme	Mauro	KU Leuven Brussel	Maurinci14	0	1	1	0	1	0	0	1	0	4	19
30	Coucke	Yari	KU Leuven Brugge	yarico	1	1	1	0	1	0	0	0	-	4	18
31	Navaneeth Holla	Navaneeth	KU Leuven	navholla	1	0	1	0	1	0	1	0	-	4	18
32	Nemec	Alex	KU Leuven	alexn90	0	½	1	0	1	0	0	½	1	4	14
33	De Baere	Aaron	UGent	Clappedbygranny	0	1	0	0	1	1	0	0	1	4	13,5
34	Jacobs	Nicolas	KU Leuven Brugge	TsarHades	0	½	1	0	0	0	1	½	1	4	13,5
35	Masil	Louis	KU Leuven Gent	Louismasil	½	0	0	½	1	½	0	½	1	4	13,25
36	Peeters	Alex	UGent	alexpeeters	1	1	0	1	0	1	0	0	1	4	13
37	Delime	Colin	ULB Owls	cdelime	0	0	1	0	1	1	1	0	0	4	13
38	Swennen	Fleur	KU Leuven	FleurS	1	0	1	1	0	1	0	0	0	4	12,5
39	Vandewalle	Rémi	UGent	Remi_Vandewalle	1	1	0	0	1	0	1	0	0	4	12
40	Van den Broeck	Joachim	UGent	Jockmator	0	1	0	0	0	1	0	1	1	4	12
41	Tanaka	Victor	Artevelde	victxr	0	0	1	1	0	1	0	1	0	4	11
42	Zein	Mohamed	ULB Owls	MoMiX1712	0	0	1	0	1	0	1	0	1	4	11
43	El Bachaoui	Rayan	KU Leuven	tankzonderdrank_20	1	½	1	0	1	-	-	-	-	3,5	15,75
44	Haupt	Simon	KU Leuven	Lamium	0	0	½	0	1	1	1	0	0	3,5	11,5
45	Chuitiev	Izaak	VIVES Noord	IsaacCss	½	0	0	1	0	1	0	0	1	3,5	10,5
46	Reynaert	Arjan	VIVES Zuid	Sneakyboy2005	0	1	0	0	0	1	½	1	0	3,5	10
47	Ali	Zia	KU Leuven	RitaEnRik	0	1	1	0	1	0	-	-	-	3	12,5
48	Verschraegen	Mats	HOGENT	MatsHangsQueen	0	1	0	1	1	-	-	-	-	3	12
49	Munoz Jiminez	Christopher	VIVES Noord	DeadPlow	0	1	0	1	0	0	½	½	0	3	10,25
50	Gharib	Khaled	UCLouvain Wolves	Khaledkvb	0	1	0	1	0	0	0	1	0	3	9,5
51	Ahmed	Shourov	AP	Churros369	0	0	0	1	0	1	1	0	0	3	9
52	Vandavelde	Oscar	UGent	misbaksels	0	0	1	0	1	0	1	0	0	3	7
53	Sonveau	Lucas	HELMo	LucaPosterizer	0	0	0	0	1	1	1	0	0	3	7
54	El Amrani	Mohamed	ULB Owls	Pipolex	0	1	0	0	0	0	1	0	1	3	6,5
55	Lemlin	Ludovic	HELHa	Luuud	0	1	0	1	0	0	0	1	0	3	6
56	Godochian	George	UCLouvain Wolves	DarkestGeo	0	0	1	0	0	0	1	0	1	3	6
57	De Sloovere	Lisa	KU Leuven St Lucas Gent	LisaDS	0	0	0	1	0	0	0	1	1	3	4,5
58	Mütsch	Annmarie	VIVES Noord	aridannie22	1	½	1	0	-	-	-	-	-	2,5	12,75
59	sakin	bilal	HELMo	bils43	0	0	0	1	1	0	0	0	0	2	4,5
60	Minh Khang	Nguyen	KU Leuven	mkhangnguyen	0	1	0	0	0	0	0	1	0	2	4
61	Ortegón	Carlos	KU Leuven	cortegon	1	0	1	0	0	0	0	-	-	2	3
62	Dellutri	Déborah	ULiège	DeboDell	1	0	0	0	-	-	-	-	-	1	4
63	Pyliser	Seppe	KU Leuven St Lucas Gent	SeppePY	0	0	0	0	0	1	0	0	0	1	1,5



Resultaten BSK Boulder  
The Island– Antwerpen  
Zaterdag 2 maart 2024



# Klassement Dames

Entry #	Naam/Name:	Voornaam/First name:	Geslacht/Sex:	Instelling/Institution:	Eindstand
1	Daele	Morgane	Dame	UCLouvain Wolves - Université catholique de Louvain	3645
2	Kreusch	Jeanne	Dame	UCLouvain Wolves - Université catholique de Louvain	3060
3	Vanstraelen	Marjolein	Vrouw/Woman	KU Leuven	1751
4	Vandekerckhove	Yuna	Dame	UCLouvain Wolves - Université catholique de Louvain	1749
5	Laurent Himmer	Marisol	Dame	HELHa - Haute Ecole Louvain en Hainaut	906
6	Tilborghs	Cathinka	Vrouw/Woman	Artesis Plantijn Hogeschool Antwerpen	781
7	IAURENT HIMMER	Maricielo	Dame	HELHa - Haute Ecole Louvain en Hainaut	781
8	Deruwe	Liedewij	Vrouw/Woman	KU Leuven	779
9	Desmaré	Maëlle	Dame	UCLouvain Wolves - Université catholique de Louvain	696
10	Wynant	Gitta	Vrouw/Woman	KU Leuven	555
11	Scholz	Isabel	Vrouw/Woman	KU Leuven	492
12	Fauvillon	Emma	Dame	HELHa - Haute Ecole Louvain en Hainaut	449
13	Körnerová	Emma	Vrouw/Woman	Universiteit Antwerpen	333
14	Jacobs	Imke	Vrouw/Woman	Universiteit Antwerpen	331
15	Vanbellingen	Alizée	Dame	HELHa - Haute Ecole Louvain en Hainaut	301
16	Sidakova	Anna	Vrouw/Woman	Universiteit Antwerpen	260
17	Weigand	Luisa	Vrouw/Woman	Universiteit Antwerpen	260
18	Dejonckheee	Aiko	Vrouw/Woman	Universiteit Antwerpen	197
19	Elpers	Laura	Vrouw/Woman	Universiteit Antwerpen	124

# Klassement Heren

Entry #	Naam/Name:	Voornaam/First name	Geslacht/Sex:	Instelling/Institution:	Eindstand
1	Bauduin	Lionel	Homme	UCLouvain Wolves - Université catholique de Louvain	1414
2	Olivares Quintanilla	Gabriel	Homme	UCLouvain Wolves - Université catholique de Louvain	1097
3	du Bois d'Enghien	Simon	Homme	UCLouvain Wolves - Université catholique de Louvain	882
4	Foret	Félix	Homme	UCLouvain Wolves - Université catholique de Louvain	879
5	Apers	Tibbe	Man	Universiteit Gent	666
6	Poullier	Pieter	Man	Universiteit Gent	631
7	Letraublou	Hektor	Man	KU Leuven	569
8	De Bruyn	Aaron	Man	Odisee	546
9	Claeijs	Killian	Man	Odisee	492
10	Winckelmans	Jonas	Man	Universiteit Antwerpen	376
11	Demoutiez	Yannis	Homme	ULiège (Liège) - Université de Liège	270
12	Thijs	Arnaud	Homme	ULiège (Liège) - Université de Liège	268
13	Mortier	Adrien	Homme	HELHa - Haute Ecole Louvain en Hainaut	245
14	Maciej	Polewiak	Man	Hogeschool West-Vlaanderen	227
15	Leitner	Lukas	Man	Universiteit Antwerpen	212
16	Kraska	Matthias	Man	Karel de Grote Hogeschool	183
17	Kempka	Oskar	Man	Universiteit Antwerpen	181
18	Diaz	Oliver Jeycob	Man	Universiteit Antwerpen	170
19	Vranken	Arthur	Man	KU Leuven	162
20	Samuel	Artigas	Man	Universiteit Antwerpen	110
21	Van Dromme	Alex	Man	Universiteit Antwerpen	109
22	Mukenge	Luc	Man	Karel de Grote Hogeschool	100
23	Pols	Daniel	Man	Artesis Plantijn Hogeschool Antwerpen	77
24	De Smedt	Yanni	Man	Artesis Plantijn Hogeschool Antwerpen	73
25	Jesus Alberto	Moro Martin	Man	Universiteit Antwerpen	21
26	Cesar	Gomez	Man	Universiteit Antwerpen	0

# Résultats du Championnat FSUB d'Escrime

Club des « 3 armes » à Gembloux

Salle des Sports de l'Ecole Horticole

Samedi 10 février 2024

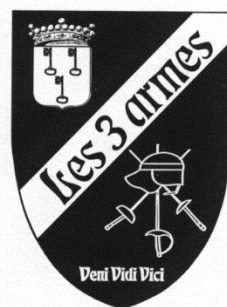

# Résultats du championnat FSUB d'Écime

## Samedi 11 février 2023 à Gembloux

### Épée Hommes

Classement général (ordre des rangs - 20 tireurs)

rg	nom prénom	club
1	RICHAUD Nathan	ULB OWLS
2	OSVART Barnabas	K.U.LEUVEN
3	HAMOLINE Gautier	U.C.LOUVAIN
4	DALLEMAGNE Louis	HENALLUX
5	FAUCONNIER Basile	UNIV.LIEGE
6	HANSENNE Arian	CAMPUS SINT LUCAS GENT
7	GALET Maxime	UNIV.LIEGE
8	FRANCOTTE Maxime	V.U.BRUSSEL
9	BOITTE Loik	UNIVERSITE MONS
10	CORDIER Auguste	UNIVERSITE MONS
11	MARICHAL Gaëtan	UNIV.LIEGE
12	DE MALEINGREAU Maxime	ERM KMS
13	VAN AELST Antoine	UNIV.NAMUR
14	GOMEZ Tomas	K.U.LEUVEN
15	TRAUTMANN Thibault	UNIVERSITE MONS
16	GILLET Antoine	UNIV.NAMUR
17	DE CRAENE Guillaume	HOGESCHOOL GENT
18	PEREBOOMS Noah	HEP LIEGE
19	GHISLAIN Maxime	ERM KMS
20	RAZANAJAO Aïna	UNIVERSITE MONS

### Épée Dames

Classement général (ordre des rangs - 4 tireuses)

rg	nom prénom	club
1	MATHIEU Bénédicte	UNIV.LIEGE
2	LELEU Margaux	UNIV.NAMUR
3	AIGUIER Lisa	UNIV.LIEGE
4	TRAUTMANN Valentine	UNIV.MONS

Tous les résultats disponibles sur :

<https://engarde-service.com/tournoi/les3armes/cbu24>

### Sabre Hommes

Classement général (ordre des rangs - 9 tireurs)

rg	nom prénom	club
1	KURVERS Lester	U.GENT
2	JACQUES Philippe	U.C.LOUVAIN
3	VAN QUAETHOV	HOGESCHOOL PXL
4	LEGRAND Gauthic	U.C.LOUVAIN
5	VOLCKAERT Cédric	U.GENT
6	STEINFORT Jules	U.C.LOUVAIN
7	SIDOROV Ivan D	K.U.LEUVEN
8	DAUCHAT Liam	U.C.LOUVAIN
9	VAN HECKE Duart	ODISEE HOGESCHO

### Sabre Dames

Classement général (ordre des rangs - 8 tireuses)

rg	nom prénom	club	nation
1	FONDEUR Apollin	U.C.LOUVAI	BEL
2	DERDE Héléne	UNIV.GENT	BEL
3	MINNE Romane	UNIV.LIEGE	BEL
4	PONCIN Auriane	UNIV.LIEGE	BEL
5	NAPOLITANO Luc	UNIV.LIEGE	BEL
6	JORDENS Héroïse	UNIV.NAMU	BEL
7	SONDERVORST K	K.U.LEUVEN	BEL
8	DE PAEPE Olivia	K.U.LEUVEN	BEL

### Fleuret Dames

Classement général (ordre des rangs - 9 tireuses)

rg	nom prénom	club	nation
1	GORNY Raphaëlle	UNIVERSITÉ LIÈGE	BEL
2	JORDENS Héroïse	UNIV.NAMUR	BEL
3	REINBOLD Mahaut	U.C.LOUVAIN	BEL
4	MARONET Andréa	U.C.LOUVAIN	BEL
5	DRYBOOMS Mano	HENALUX	BEL
6	DACO Sophie	U.C.LOUVAIN	BEL
7	BESLIER Clara	VRIJE UNIVERSITEIT BRUS	BEL
8	DUPONT Apolline	U.C.LOUVAIN	BEL
9	COLIGNON Marie	U.C.LOUVAIN	BEL

### Fleuret Hommes

Classement général (ordre des rangs - 9 tireurs)

rg	nom prénom	club
1	GENBRUGGE Sem	VRIJE UNIV.BRUSSEL <i>Thomas More</i>
2	FAUCONNIER Bas	UNIV.LIEGE
3	NAVAS Timothy	UNIV.GENT
4	GASPERINI Loïc	HEP LIEGE
5	REINBOLD Ulysse	U.C.LOUVAIN
6	ANDRUETAN Vlad	VRIJE UNIV.BRUSSEL
7	LEONARD Alexan	HEP LIEGE
8	NICOLAS Louis	U.MONS
9	DI MASCIO Mattéo	HEP HAINAUT CONDORC

# Résultats du Championnat FSUB de Gymnastique

BLOCRY – UCLouvain

Lundi 18 mars 2024



résultats généraux ind.

Class	Dos	Nom	Unif	Saut	Barres	Poutre	Sol	Total
1	7	Kohnenmergen Emma	UCLouvain	11,600	12,500	11,650	12,567	48,32
2	39	Glineur Anaëlle	ULiège	12,167	13,150	10,000	12,033	47,35
3	34	Goffard Célia	HEPL	11,933	12,150	11,200	11,767	47,05
4	25	Clearhout Coline	HeVINCI	12,133	13,150	9,450	11,567	46,30
6	2	Angeli Eloïne	VUB	11,633	12,000	9,700	10,700	44,03
7	11	Simon Charlotte	UCLouvain	11,667	10,650	10,000	11,700	44,02
8	3	Van Oppens Lisa	UAntwerp	10,733	13,000	8,750	11,400	43,88
9	28	Thomas Elisa	HeVINCI	12,500	10,950	8,050	11,967	43,47
10	35	Calmant Kérianne	HEPL	10,767	9,900	8,800	11,133	40,60
11	16	Van Deyck Meredith	KULeuven 1	12,100	7,050	9,300	10,767	39,22
12	19	Lecomte Adélaïde	KULeuven 2	10,533	9,100	9,400	9,900	38,93
13	4	Ernst Lise	HEPL	11,000	9,400	9,300	8,700	38,40
14	1	Engels Charlotte	VUB	10,367	10,250	7,500	9,767	37,88
15	36	Arnauts Vikky	HEPL	11,467	6,750	9,300	10,267	37,78
16	31	Aerts Lois	KULeuven 3	10,867	8,600	8,200	8,900	36,57
17	29	Ysenbaert Elena	UGent	11,533	5,650	4,700	11,633	33,52
18	44	Schoonbroodt Clara	ULiège	11,733	10,150	0,000	10,967	32,85
19	21	Van Deyck Emoa	KULeuven 2	9,533	5,950	6,250	7,200	28,93



### Résultats généraux équipes

Dos	Nom	Unif	Saut	Barres	Poutre	Sol	
1	Engels Charlotte	VUB	10,367	10,250	7,500	9,767	
2	Angeli Eloïne	VUB	11,633	12,000	9,700	10,700	
3	Van Oppens Lisa	UAntwerp	10,733	13,000	8,750	11,400	
4	Ernst Lise	HELMO	11,000	9,400	9,300	8,700	
			<b>33,367</b>	<b>35,250</b>	<b>27,750</b>	<b>31,867</b>	<b>128,233333</b>

1	UCLouvain	139,300
2	HeVinci	136,667
3	ULiège	133,167
4	KULeuven 1	128,167
5	HEPL	125,433
6	KULeuven 2	109,683
7	KULeuven 3	98,4

Dos	Nom	Unif	Saut	Barres	Poutre	Sol	
5	Aulotte Enola	UCLouvain	0,000	9,600	0,000	0,000	
6	Nachtergaele Marie	UCLouvain	0,000	0,000	11,200	0,000	
7	Kohnenmergen Emma	UCLouvain	11,600	12,500	11,650	12,567	
8	Moulin Elodie	UCLouvain	0,000	0,000	0,000	11,733	
9	Gronemberger Eléa	UCLouvain	11,833	11,550	10,550	0,000	
10	Michiels Sophie	UCLouvain	11,700	0,000	0,000	11,567	
11	Simon Charlotte	UCLouvain	11,667	10,650	10,000	11,700	
			<b>35,200</b>	<b>34,700</b>	<b>33,400</b>	<b>36,000</b>	<b>139,300</b>

Dos	Nom	Unif	Saut	Barres	Poutre	Sol	
12	DE NEEF Kay-Li	KULeuven 1	0,000	11,150	7,800	9,200	
13	Geraerts Kaat	KULeuven 1	11,567	12,050	8,150	0,000	
14	Haneca Louise	KULeuven 1	11,633	9,850	0,000	11,133	
15	Van Hove Eleonore	KULeuven 1	10,567	0,000	9,200	11,267	
16	Van Deyck Meredith	KULeuven 1	12,100	7,050	9,300	10,767	
			<b>35,300</b>	<b>33,050</b>	<b>26,650</b>	<b>33,167</b>	<b>128,167</b>



Résultats généraux équipes

Dos	Nom	Unif	Saut	Barres	Poutre	Sol	
17	Aerts Mia	KULeuven 2	10,600	8,550	0,000	9,267	
18	Bloemen Irene	KULeuven 2	9,633	8,550	0,000	0,000	
19	Lecomte Adélaïde	KULeuven 2	10,533	9,100	9,400	9,900	
20	Van Craeynest Nien	KULeuven 2	0,000	0,000	8,300	9,600	
21	Van Deyck Emoa	KULeuven 2	9,533	5,950	6,250	7,200	
22	Benaets Femke	KULeuven 2	0,000	0,000	0,000	0,000	
			30,767	26,200	23,950	28,767	109,683333

Dos	Nom	Unif	Saut	Barres	Poutre	Sol	
23	Bruyeer Sabine	HeVINCI	0,000	9,600	9,800	0,000	
24	Jacqmin Camille	HeVINCI	0,000	11,600	10,850	0,000	
25	Clearhout Coline	HeVINCI	12,133	13,150	9,450	11,567	
26	Jadot Emilie	HeVINCI	10,800	0,000	0,000	11,233	
27	Delahaut Flavie	HeVINCI	11,467	0,000	3,100	11,000	
28	Thomas Elisa	HeVINCI	12,500	10,950	8,050	11,967	
			36,100	35,700	30,100	34,767	136,666667

Dos	Nom	Unif	Saut	Barres	Poutre	Sol	
30	Reybrouck Marina	KULeuven 3	10,233	9,100	0,000	8,367	
31	Aerts Lois	KULeuven 3	10,867	8,600	8,200	8,900	
32	Liedt Nele	KULeuven 3	0,000	0,000	0,000	9,900	
33	De Clercq Cassandra	KULeuven 3	12,333	4,300	7,600	0,000	
			33,433	22,000	15,800	27,167	98,4

Dos	Nom	Unif	Saut	Barres	Poutre	Sol	
34	Goffard Célia	HEPL	11,933	12,150	11,200	11,767	
35	Calmant Kérianne	HEPL	10,767	9,900	8,800	11,133	
36	Arnauts Vikky	HEPL	11,467	6,750	9,300	10,267	
37	Jungers Oriane	HEPL	0,000	0,000	0,000	8,733	
			34,167	28,800	29,300	33,167	125,433333

### Résultats généraux équipes

Dos	Nom	Unif	Saut	Barres	Poutre	Sol	
38	Gendebien Charlotte	ULiège	0,000	0,000	0,000	10,000	
39	Glineur Anaëlle	ULiège	12,167	13,150	10,000	12,033	
40	Collard Julie	ULiège	10,433	0,000	7,850	0,000	
41	Maurel Solenne	ULiège	11,667	10,600	11,550	0,000	
42	Odobescu Odile	ULiège	0,000	0,000	9,150	0,000	
43	Palermini Sarah	ULiège	0,000	9,200	0,000	0,000	
44	Schoonbroodt Clara	ULiège	11,733	10,150	0,000	10,967	
45	Belche Othilie	ULiège	0,000	0,000	0,000	9,100	
			35,567	33,900	30,700	33,000	133,166667

## Résultats Saut

Class	Dos	Nom	Unif	Saut
1	28	Thomas Elisa	HeVINCI	12,500
2	33	De Clercq Cassandra	KULeuven 3	12,333
3	39	Glineur Anaëlle	ULiège	12,167
4	25	Clearhout Coline	HeVINCI	12,133
5	16	Van Deyck Meredith	KULeuven 1	12,100
6	34	Goffard Célia	HEPL	11,933
7	9	Gronemberger Eléa	UCLouvain	11,833
8	44	Schoonbroodt Clara	ULiège	11,733
9	10	Michiels Sophie	UCLouvain	11,700
10	11	Simon Charlotte	UCLouvain	11,667
10	41	Maurel Solenne	ULiège	11,667
12	2	Angeli Eloïne	VUB	11,633
12	14	Haneca Louise	KULeuven 1	11,633
14	7	Kohnenmergen Emma	UCLouvain	11,600
15	13	Geraerts Kaat	KULeuven 1	11,567
16	29	Ysenbaert Elena	UGent	11,533
17	27	Delahaut Flavie	HeVINCI	11,467
17	36	Arnauts Vikky	HEPL	11,467
19	4	Ernst Lise	HELMO	11,000
20	31	Aerts Lois	KULeuven 3	10,867
21	26	Jadot Emilie	HeVINCI	10,800
22	35	Calmant Kérianne	HEPL	10,767
23	3	Van Oppens Lisa	UAntwerp	10,733
24	17	Aerts Mia	KULeuven 2	10,600
25	15	Van Hove Eleonore	KULeuven 1	10,567
26	19	Lecomte Adélaïde	KULeuven 2	10,533
27	40	Collard Julie	ULiège	10,433
28	1	Engels Charlotte	VUB	10,367
29	30	Reybrouck Marina	KULeuven 3	10,233
30	18	Bloemen Irene	KULeuven 2	9,633
31	21	Van Deyck Emoa	KULeuven 2	9,533

## Résultats Barres

Class	Dos	Nom	Unif	Barres
1	25	Clearhout Coline	HeVINCI	13,150
1	39	Glineur Anaëlle	ULiège	13,150
3	3	Van Oppens Lisa	UAntwerp	13,000
4	7	Kohnenmergen Emma	UCLouvain	12,500
5	34	Goffard Célia	HEPL	12,150
6	13	Geraerts Kaat	KULeuven 1	12,050
7	2	Angeli Eloïne	VUB	12,000
8	24	Jacqmin Camille	HeVINCI	11,600
9	9	Gronemberger Eléa	UCLouvain	11,550
10	12	DE NEEF Kay-Li	KULeuven 1	11,150
11	28	Thomas Elisa	HeVINCI	10,950
12	11	Simon Charlotte	UCLouvain	10,650
13	41	Maurel Solenne	ULiège	10,600
14	1	Engels Charlotte	VUB	10,250
15	35	Calmant Kérianne	HEPL	9,900
16	14	Haneca Louise	KULeuven 1	9,850
17	23	Bruyeer Sabine	HeVINCI	9,600
17	5	Aulotte Enola	UCLouvain	9,600
18	4	Ernst Lise	HELMO	9,400
19	43	Palermi Sarah	ULiège	9,200
20	19	Lecomte Adélaïde	KULeuven 2	9,100
20	30	Reybrouck Marina	KULeuven 3	9,100
21	31	Aerts Lois	KULeuven 3	8,600
22	17	Aerts Mia	KULeuven 2	8,550
23	18	Bloemen Irene	KULeuven 2	8,550
24	16	Van Deyck Meredith	KULeuven 1	7,050
25	36	Arnauts Vikky	HEPL	6,750
26	21	Van Deyck Emoa	KULeuven 2	5,950
27	29	Ysenbaert Elena	UGent	5,650
28	33	De Clercq Cassandra	KULeuven 3	4,300

## Résultats Poutre

Class	Dos	Nom	Unif	Poutre
1	7	Kohnenmergen Emma	UCLouvain	11,650
2	41	Maurel Solenne	ULiège	11,550
3	6	Nachtergaele Marie	UCLouvain	11,200
3	34	Goffard Célia	HEPL	11,200
5	24	Jacqmin Camille	HeVINCI	10,850
6	9	Gronemberger Eléa	UCLouvain	10,550
7	11	Simon Charlotte	UCLouvain	10,000
7	39	Glineur Anaëlle	ULiège	10,000
9	23	Bruyeer Sabine	HeVINCI	9,800
10	2	Angeli Eloïne	VUB	9,700
11	25	Clearhout Coline	HeVINCI	9,450
12	19	Lecomte Adélaïde	KULeuven 2	9,400
13	4	Ernst Lise	HEPL	9,300
13	16	Van Deyck Meredith	KULeuven 1	9,300
13	36	Arnauts Vikky	HEPL	9,300
16	15	Van Hove Eleonore	KULeuven 1	9,200
17	42	Odobescu Odile	ULiège	9,150
18	35	Calmant Kérianne	HEPL	8,800
19	3	Van Oppens Lisa	UAntwerp	8,750
20	20	Van Craeynest Nien	KULeuven 2	8,300
21	31	Aerts Lois	KULeuven 3	8,200
22	13	Geraerts Kaat	KULeuven 1	8,150
23	28	Thomas Elisa	HeVINCI	8,050
24	40	Collard Julie	ULiège	7,850
25	12	DE NEEF Kay-Li	KULeuven 1	7,800
26	33	De Clercq Cassandra	KULeuven 3	7,600
27	1	Engels Charlotte	VUB	7,500
28	21	Van Deyck Emoa	KULeuven 2	6,250
29	29	Ysenbaert Elena	UGent	4,700
30	27	Delahaut Flavie	HeVINCI	3,100

## Résultats Sol

Class	Dos	Nom	Unif	Sol
1	7	Kohnenmergen Emma	UCLouvain	12,567
2	39	Glineur Anaëlle	ULiège	12,033
3	28	Thomas Elisa	HeVINCI	11,967
4	34	Goffard Célia	HEPL	11,767
5	8	Moulin Elodie	UCLouvain	11,733
6	11	Simon Charlotte	UCLouvain	11,700
7	29	Ysenbaert Elena	UGent	11,633
8	10	Michiels Sophie	UCLouvain	11,567
8	25	Clearhout Coline	HeVINCI	11,567
10	3	Van Oppens Lisa	UAntwerp	11,400
11	15	Van Hove Eleonore	KULeuven 1	11,267
12	26	Jadot Emilie	HeVINCI	11,233
13	35	Calmant Kérianne	HEPL	11,133
13	14	Haneca Louise	KULeuven 1	11,133
14	27	Delahaut Flavie	HeVINCI	11,000
15	44	Schoonbroodt Clara	ULiège	10,967
16	16	Van Deyck Meredith	KULeuven 1	10,767
17	2	Angeli Eloïne	VUB	10,700
18	36	Arnauts Vikky	HEPL	10,267
19	38	Gendebien Charlotte	ULiège	10,000
20	19	Lecomte Adélaïde	KULeuven 2	9,900
21	32	Liedt Nele	KULeuven 3	9,900
22	1	Engels Charlotte	VUB	9,767
23	20	Van Craeynest Nien	KULeuven 2	9,600
24	17	Aerts Mia	KULeuven 2	9,267
25	12	DE NEEF Kay-Li	KULeuven 1	9,200
26	45	Belche Othilie	ULiège	9,100
27	31	Aerts Lois	KULeuven 3	8,900
28	37	Jungers Oriane	HEPL	8,733
29	4	Ernst Lise	HELMO	8,700
30	30	Reybrouck Marina	KULeuven 3	8,367
31	21	Van Deyck Emoa	KULeuven 2	7,200

Résultats ind.

Class	Dos	Nom	Unif	Sol	Arçons	Anneaux	Saut	Barres	Rek	
1	66	Leemans Andi	VUB	12,367	10,700	12,333	12,700	12,300	12,733	73,133333
2	46	Maxence Wiseur	UCLouvain	11,867	12,333	12,767	10,767	12,000	12,933	72,666667
3	47	Marceau Wiseur	UCLouvain	12,733	10,633	13,467	10,833	12,167	12,067	71,9
4	48	Valentin Wiseur	UCLouvain	9,300	11,267	12,867	12,000	12,333	11,567	69,333333
5	62	Len Kelambi Arachchige	UGent	12,067	10,533	11,667	11,967	9,667	11,767	67,666667
6	61	Van Lomberghen Michiel	UGent	11,267	6,400	11,800	11,167	13,000	12,433	66,066667

## Résultats équipes

Dos	Nom	Unif	Sol	Arçons	Anneaux	Saut	Barres	Rek	
46	Maxence Wiseur	UCLouvain	11,867	12,333	12,767	10,767	12,000	12,933	
47	Marceau Wiseur	UCLouvain	12,733	10,633	13,467	10,833	12,167	12,067	
48	Valentin Wiseur	UCLouvain	9,300	11,267	12,867	12,000	12,333	11,567	
49	Annaël Papin	UCLouvain	0,000	0,000	0,000	0,000	0,000	0,000	
50	Yohan Havegeer	UCLouvain	0,000	0,000	9,167	0,000	0,000	0,000	
51	Tristan Bouvrat	UCLouvain	12,967	5,533	0,000	11,067	9,800	8,100	
			<b>37,567</b>	<b>34,233</b>	<b>39,100</b>	<b>33,900</b>	<b>36,500</b>	<b>36,567</b>	<b>217,86667</b>

1 UCLouvain 217,8667  
 2 U Gent 204,7333  
 3 KUL 197,7333

Dos	Nom	Unif	Sol	Arçons	Anneaux	Saut	Barres	Rek	
52	Caponi Matteo	KULeuven	0,000	10,333	12,600	0,000	13,800	11,200	
53	Schellens Juul	KULeuven	9,433	8,100	0,000	10,867	9,933	0,000	
54	Steenhouwer Arne	KULeuven	12,000	0,000	11,333	11,700	0,000	11,567	
55	Devaere Vic	KULeuven	10,700	0,000	0,000	10,333	10,333	10,567	
56	Dobbels Christophe	KULeuven	0,000	9,533	0,000	0,000	0,000	0,000	
57	Marchand Victor	KULeuven	0,000	0,000	0,000	0,000	0,000	0,000	
58	Van den Broeck Stef	KULeuven	0,000	0,000	11,067	11,400	0,000	10,767	
59	Maes Oscar	KULeuven	0,000	7,633	10,867	0,000	11,000	0,000	
			<b>32,133</b>	<b>27,967</b>	<b>35,000</b>	<b>33,967</b>	<b>35,133</b>	<b>33,533</b>	<b>197,73333</b>

Dos	Nom	Unif	Sol	Arçons	Anneaux	Saut	Barres	Rek	
61	Van Lomberghen Michiel	UGent	11,267	6,400	11,800	11,167	13,000	12,433	
62	Len Kelambi Arachchige	UGent	12,067	10,533	11,667	11,967	9,667	11,767	
63	Xander Vereecken	UGent	11,000	0,000	0,000	10,733	0,000	11,500	
64	Dries De Schepper	UGent	13,267	0,000	0,000	13,000	12,767	0,000	
65	Everaert Simon	UGent	0,000	9,800	10,667	0,000	0,000	8,033	
			<b>36,600</b>	<b>26,733</b>	<b>34,133</b>	<b>36,133</b>	<b>35,433</b>	<b>35,700</b>	<b>204,73333</b>



## Résultats Sol

Class	Dos	Nom	Unif	Sol
1	64	Dries De Schepper	UGent	13,266667
2	51	Tristan Bouvrat	UCLouvain	12,967
3	47	Marceau Wiseur	UCLouvain	12,733
4	66	Leemans Andi	VUB	12,367
5	62	Len Kelambi Arachchige	UGent	12,066667
6	54	Steenhouwer Arne	KULeuven	12
7	46	Maxence Wiseur	UCLouvain	11,867
8	61	Van Lomberghen Michiel	UGent	11,266667
9	63	Xander Vereecken	UGent	11
10	55	Devaere Vic	KULeuven	10,7
11	53	Schellens Juul	KULeuven	9,4333333
12	48	Valentin Wiseur	UCLouvain	9,300

## Résultats arçons

Class	Dos	Nom	Unif	Arçons
1	46	Maxence Wiseur	UCLouvain	12,333333
2	48	Valentin Wiseur	UCLouvain	11,266667
3	66	Leemans Andi	VUB	10,7
4	47	Marceau Wiseur	UCLouvain	10,633333
5	62	Len Kelambi Arachchige	UGent	10,533333
6	52	Caponi Matteo	KULeuven	10,333333
7	65	Everaert Simon	UGent	9,8
8	56	Dobbels Christophe	KULeuven	9,533333
9	53	Schellens Juul	KULeuven	8,1
10	59	Maes Oscar	KULeuven	7,633333
11	61	Van Lomberghen Michiel	UGent	6,4
12	51	Tristan Bouvrat	UCLouvain	5,533333

### Résultats anneaux

Class	Dos	Nom	Unif	Anneaux
1	47	Marceau Wiseur	UCLouvain	13,466667
2	48	Valentin Wiseur	UCLouvain	12,866667
3	46	Maxence Wiseur	UCLouvain	12,766667
4	52	Caponi Matteo	KULeuven	12,6
5	66	Leemans Andi	VUB	12,333333
6	61	Van Lomberghen Michiel	UGent	11,8
7	62	Len Kelambi Arachchige	UGent	11,666667
8	54	Steenhouwer Arne	KULeuven	11,333333
9	58	Van den Broeck Stef	KULeuven	11,066667
10	59	Maes Oscar	KULeuven	10,866667
11	65	Everaert Simon	UGent	10,666667
12	50	Yohan Havegeer	UCLouvain	9,166667

## Résultats saut

Class	Dos	Nom	Unif	Saut
1	64	Dries De Schepper	UGent	13
2	66	Leemans Andi	VUB	12,7
3	48	Valentin Wiseur	UCLouvain	12
4	62	Len Kelambi Arachchige	UGent	11,966667
5	54	Steenhouwer Arne	KULeuven	11,7
6	55	Devaere Vic	KULeuven	11,4
7	61	Van Lomberghen Michiel	UGent	11,166667
8	51	Tristan Bouvrat	UCLouvain	11,066667
9	53	Schellens Juul	KULeuven	10,866667
10	47	Marceau Wiseur	UCLouvain	10,833333
11	46	Maxence Wiseur	UCLouvain	10,766667
12	63	Xander Vereecken	UGent	10,733333
13	52	Caponi Matteo	KULeuven	10,333333

## Résultats barres

Class	Dos	Nom	Unif	Barres
1	52	Caponi Matteo	KULeuven	13,8
2	61	Van Lomberghen Michiel	UGent	13
3	64	Dries De Schepper	UGent	12,766667
4	48	Valentin Wiseur	UCLouvain	12,333333
5	66	Leemans Andi	VUB	12,3
6	47	Marceau Wiseur	UCLouvain	12,166667
7	46	Maxence Wiseur	UCLouvain	12
8	59	Maes Oscar	KULeuven	11
9	55	Devaere Vic	KULeuven	10,333333
10	53	Schellens Juul	KULeuven	9,933333
11	51	Tristan Bouvrat	UCLouvain	9,8
12	62	Len Kelambi Arachchige	UGent	9,666667

résultats Rek

Class	Dos	Nom	Unif	Rek
1	46	Maxence Wiseur	UCLouvain	12,933333
2	66	Leemans Andi	VUB	12,733333
3	61	Van Lomberghen Michiel	UGent	12,433333
4	47	Marceau Wiseur	UCLouvain	12,066667
5	62	Len Kelambi Arachchige	UGent	11,766667
6	48	Valentin Wiseur	UCLouvain	11,566667
6	54	Steenhouwer Arne	KULeuven	11,566667
8	63	Xander Vereecken	UGent	11,5
9	52	Caponi Matteo	KULeuven	11,2
10	58	Van den Broeck Stef	KULeuven	10,766667
11	55	Devaere Vic	KULeuven	10,566667
12	51	Tristan Bouvrat	UCLouvain	8,1
13	65	Everaert Simon	UGent	8,033333

Résultats du Championnat FSUB  
de Judo Individuel  
Salle de l'UMONS  
Mercredi 13 décembre 2023



# FSUB Judo Championship 13/12/2023 D-57

B.U.S.F. - F.S.U.B.



Competitors: 6

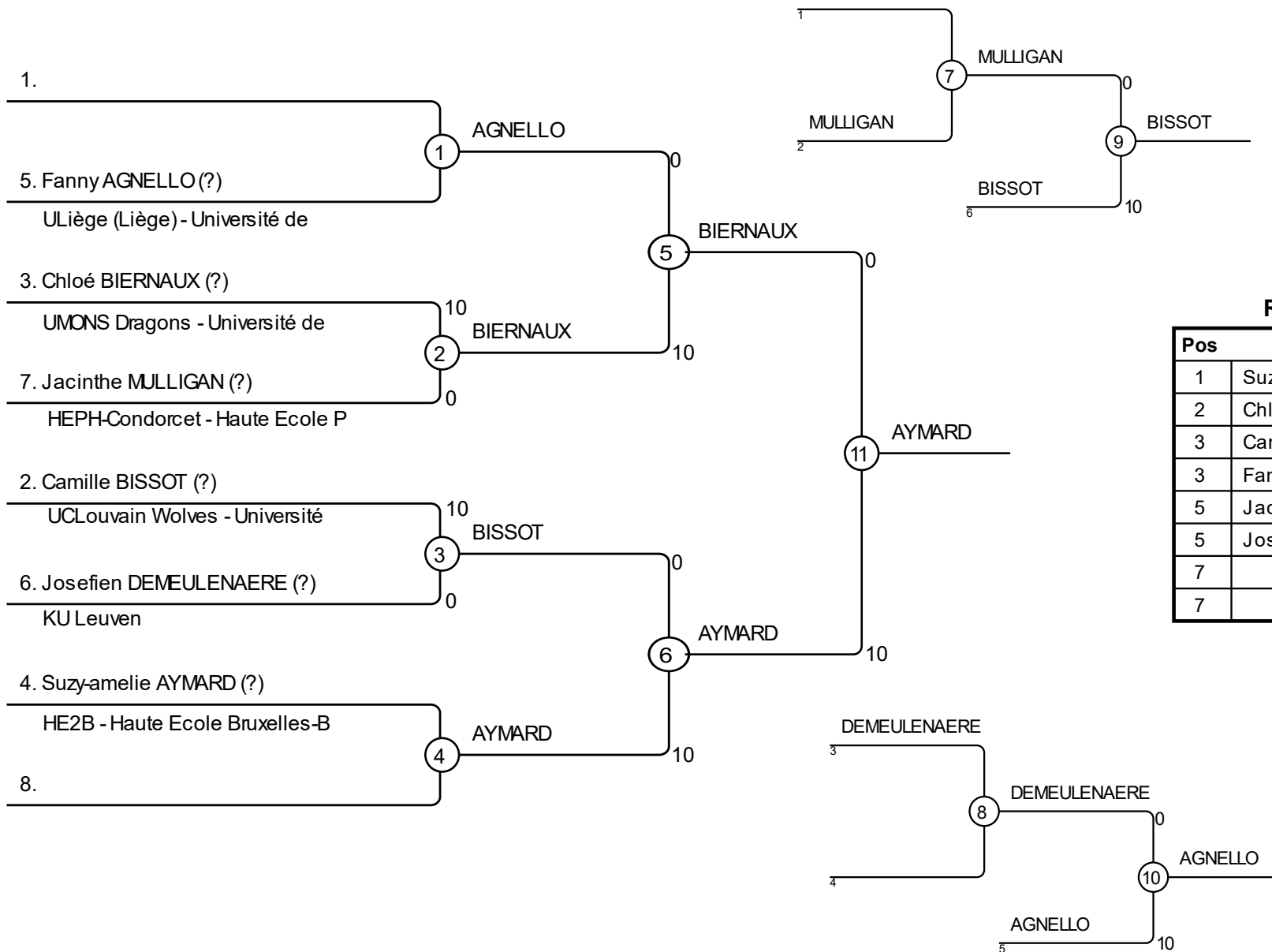

## Results

Pos	Name
1	Suzy-amelie AYMARD HE2B - Haute Ecole Bruxelles-B
2	Chloé BIERNAUX UMONS Dragons - Université de
3	Camille BISSOT UCLouvain Wolves - Université
3	Fanny AGNELLO ULiège (Liège) - Université de
5	Jacinthe MULLIGAN HEPH-Condorcet - Haute Ecole
5	Josefien DEMEULENAERE KU Leuven
7	
7	



# FSUB Judo Championship 13/12/2023 D-63

B.U.S.F. - F.S.U.B.



Competitors: 7

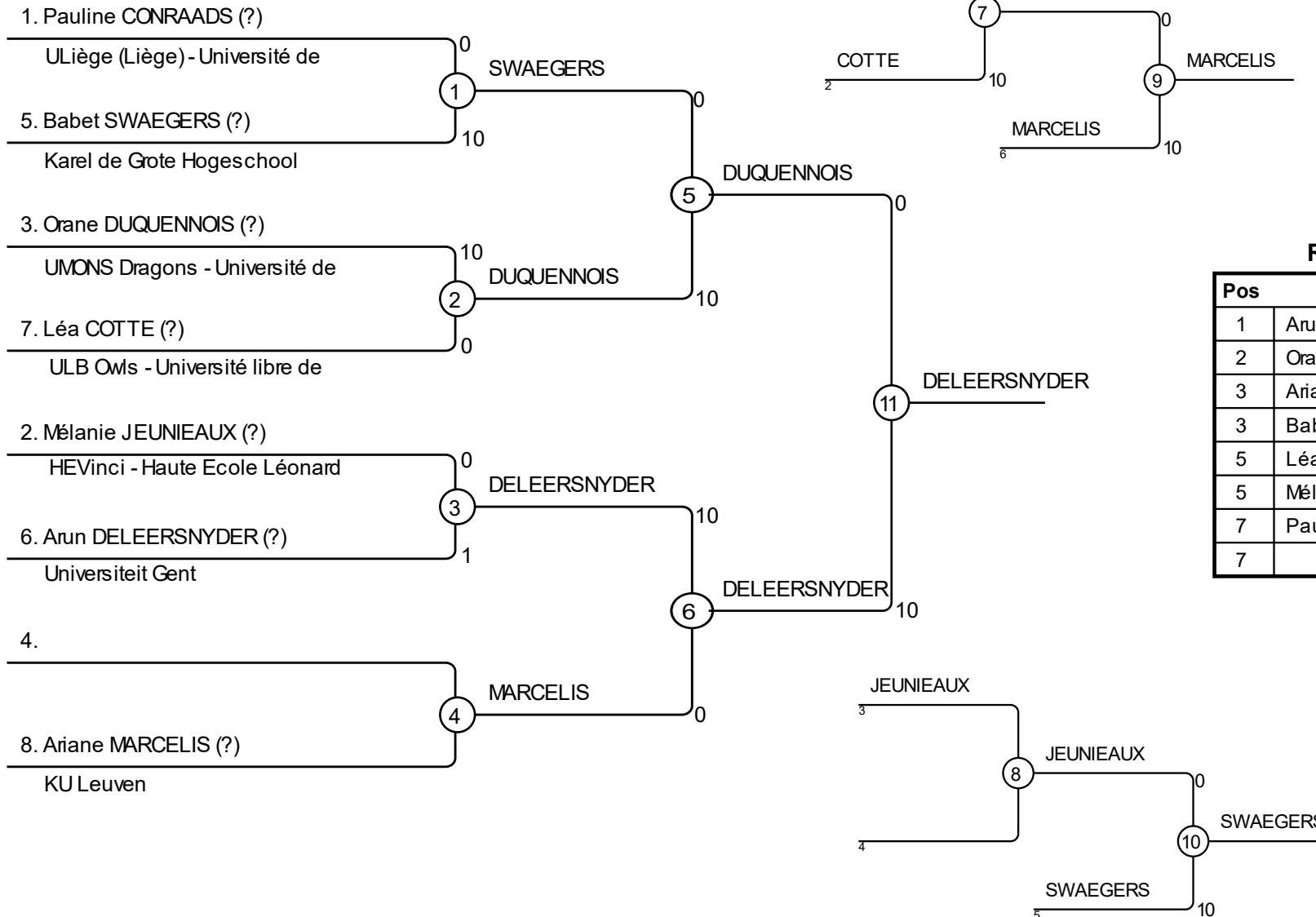

## Results

Pos	Name
1	Arun DELEERSNYDER Universiteit Gent
2	Orane DUQUENNOIS UMONS Dragons - Université de
3	Ariane MARCELIS KU Leuven
3	Babet SWAEGERS Karel de Grote Hogeschool
5	Léa COTTE ULB Owls - Université libre de
5	Mélanie JEUNIEAUX HEVinci - Haute Ecole Léonard
7	Pauline CONRAADS ULiège (Liège) - Université de
7	

# FSUB Judo Championship 13/12/2023 D-70



Competitors: 7

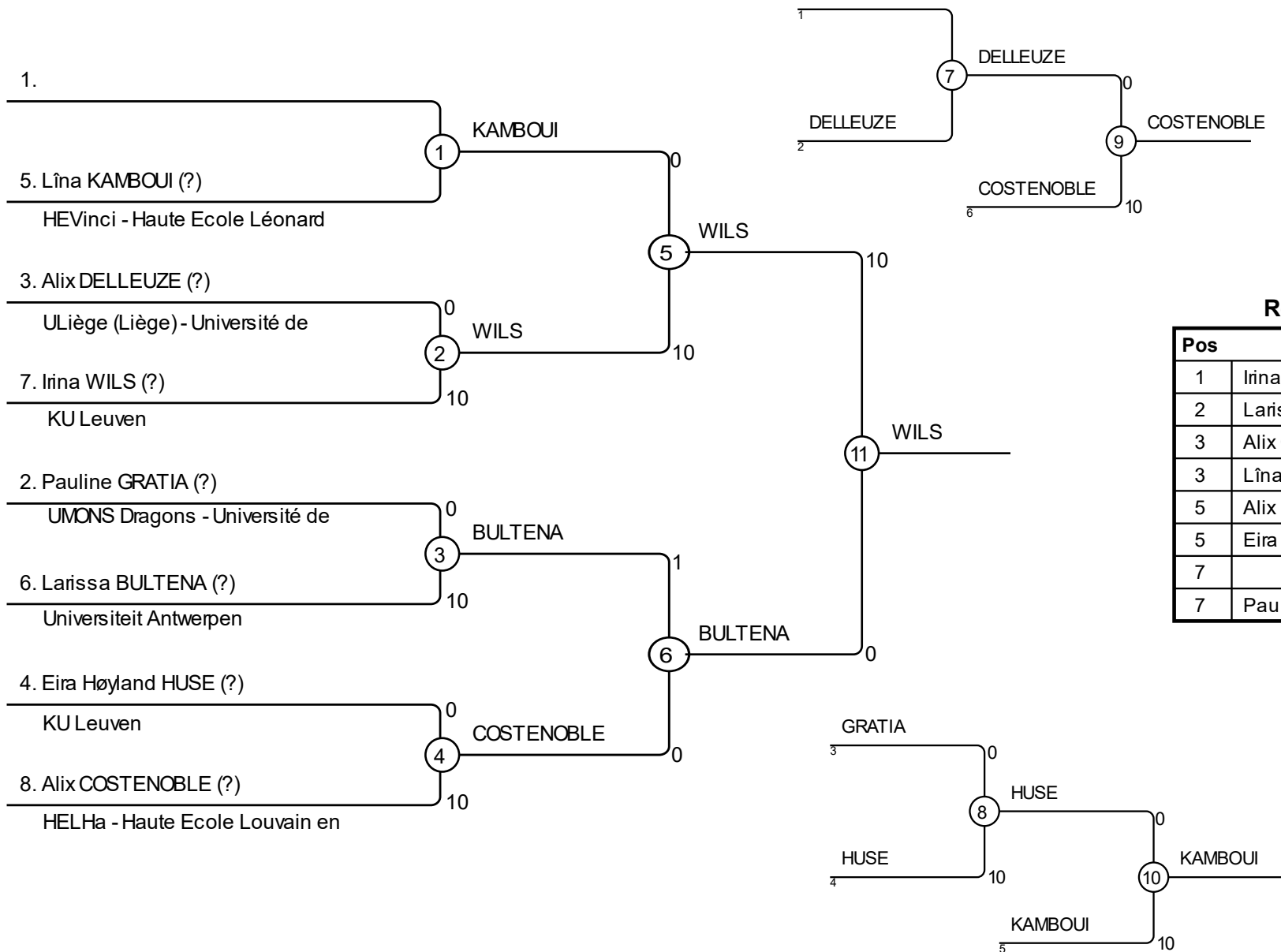

## Results

Pos	Name
1	Irina WILS KU Leuven
2	Larissa BULTENA Universiteit Antwerpen
3	Alix COSTENOBLE HELHa - Haute Ecole Louvain en
3	Lina KAMBOUI HEVinci - Haute Ecole Léonard
5	Alix DELLEUZE ULiège (Liège) - Université de
5	Eira Høyland HUSE KU Leuven
7	
7	Pauline GRATIA UMONS Dragons - Université de

# FSUB Judo Championship 13/12/2023 D-78

Competitors: 1

## Competitors

#	Name	Club	1	Wins	Pts	Pos
1	Lucie HECQ (?) UCLouvain Wolves - Université			0	0	1

## Matches

Match	White	Blue	Result	Time
-------	-------	------	--------	------

## Results

Pos	Name
1	Lucie HECQ UCLouvain Wolves - Université

B.U.S.F. - F.S.U.B.



# FSUB Judo Championship 13/12/2023 H+100

Competitors: 3

## Competitors

#	Name	Club	1	2	3	Wins	Pts	Pos
1	Jakub FRATCZAK (?) Hogeschool West-Vlaanderen			0	10	1	10	2
2	Pjotr DEBRUYNE (?) Hogeschool West-Vlaanderen		10		10	2	20	1
3	Lucas DUMORTIER (?) HEH - Haute Ecole en Hainaut		0	0		0	0	3

## Matches

Match	White			Blue	Result	Time
1	Jakub FRATCZAK	1	2	Pjotr DEBRUYNE	0 - 10	
2	Jakub FRATCZAK	1	3	Lucas DUMORTIER	10 - 0	
3	Pjotr DEBRUYNE	2	3	Lucas DUMORTIER	10 - 0	

## Results

Pos	Name
1	Pjotr DEBRUYNE Hogeschool West-Vlaanderen
2	Jakub FRATCZAK Hogeschool West-Vlaanderen
3	Lucas DUMORTIER HEH - Haute Ecole en Hainaut

B.U.S.F. - F.S.U.B.



# FSUB Judo Championship 13/12/2023 H-60

B.U.S.F. - F.S.U.B.



Competitors: 6

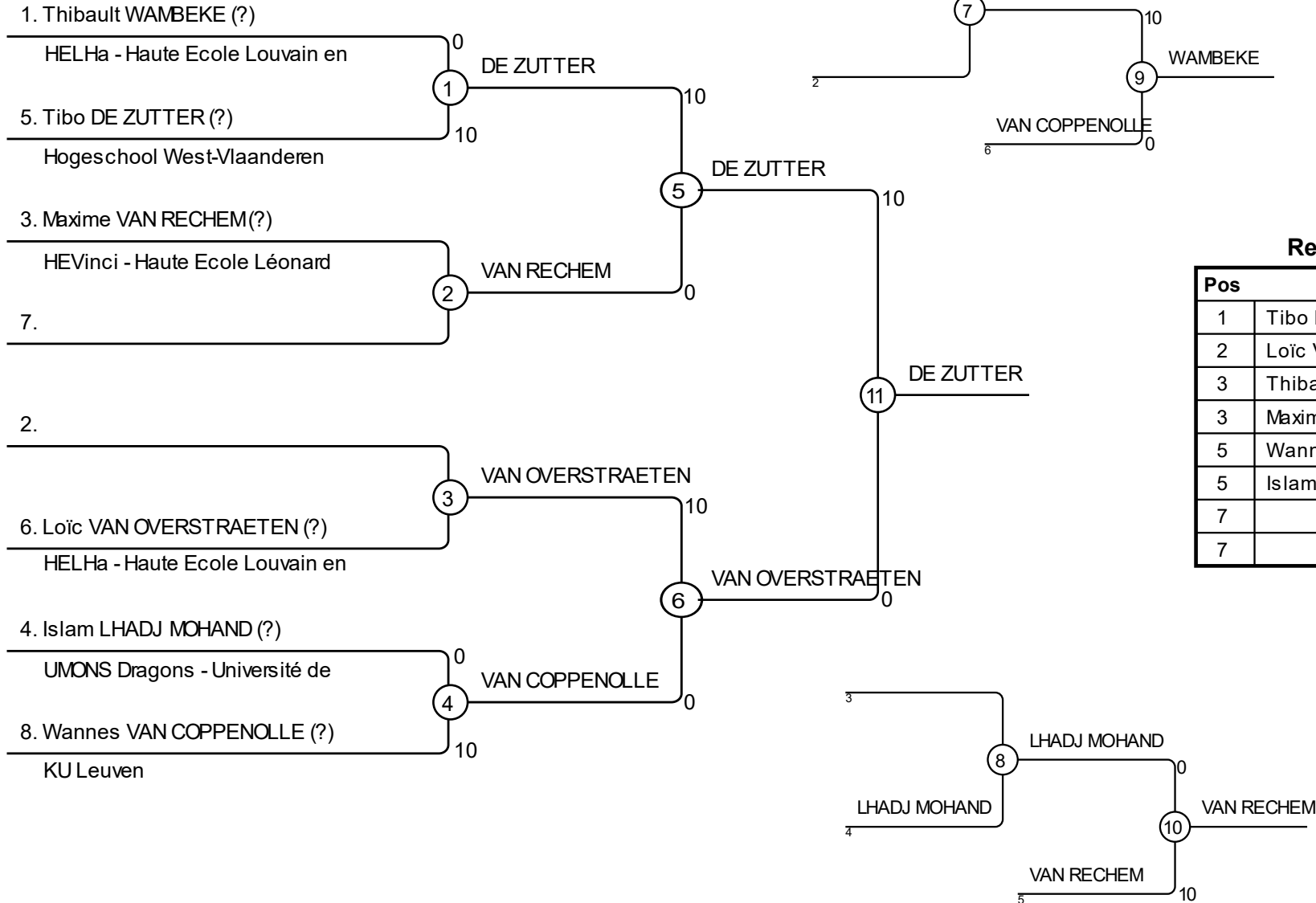

## Results

Pos	Name
1	Tibo DE ZUTTER Hogeschool West-Vlaanderen
2	Loïc VAN OVERSTRAETEN HELHa - Haute Ecole Louvain en
3	Thibault WAMBEKE HELHa - Haute Ecole Louvain en
3	Maxime VAN RECHEM HEVinci - Haute Ecole Léonard
5	Wannes VAN COPPENOLLE KU Leuven
5	Islam LHADJ MOHAND UMONS Dragons - Université de
7	
7	

# FSUB Judo Championship 13/12/2023 H-66

Competitors: 12

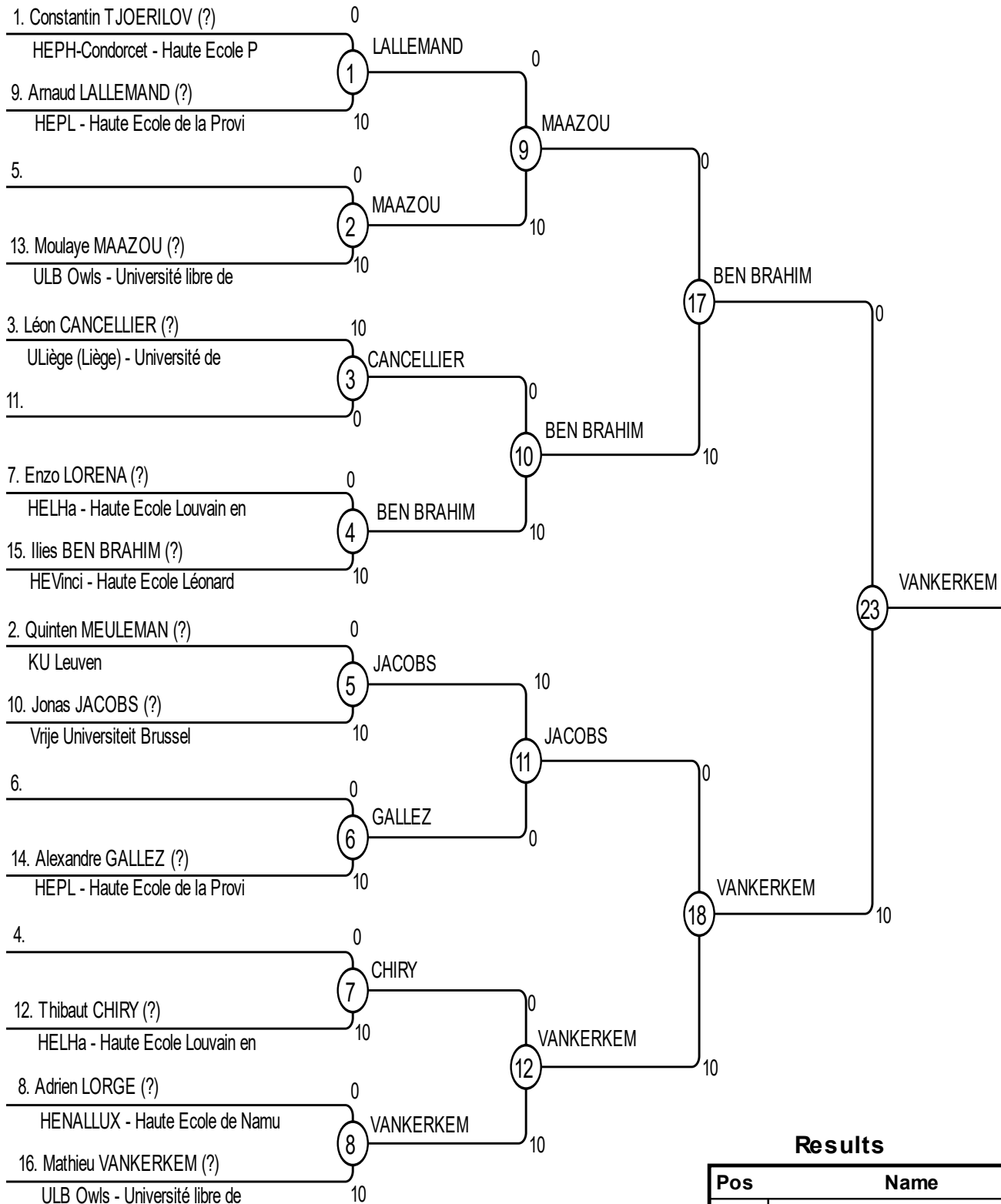

## Results

Pos	Name
1	Mathieu VANKERKEM ULB Owls - Univers
2	Ilies BEN BRAHIM HEVinci - Haute Ecole L
3	Jonas JACOBS Vrije Universiteit Brussel
3	Quinten MEULEMAN KU Leuven
5	Arnaud LALLEMAND HEPL - Haute Ecole
5	Moulaye MAAZOU ULB Owls - Université li
7	Enzo LORENA HELHa - Haute Ecole Louv
7	Adrien LORGE HENALLUX - Haute Ecole

B.U.S.F. - F.S.U.B.



# REPECHAGE

# FSUB Judo Championship 13/12/2023 H-66

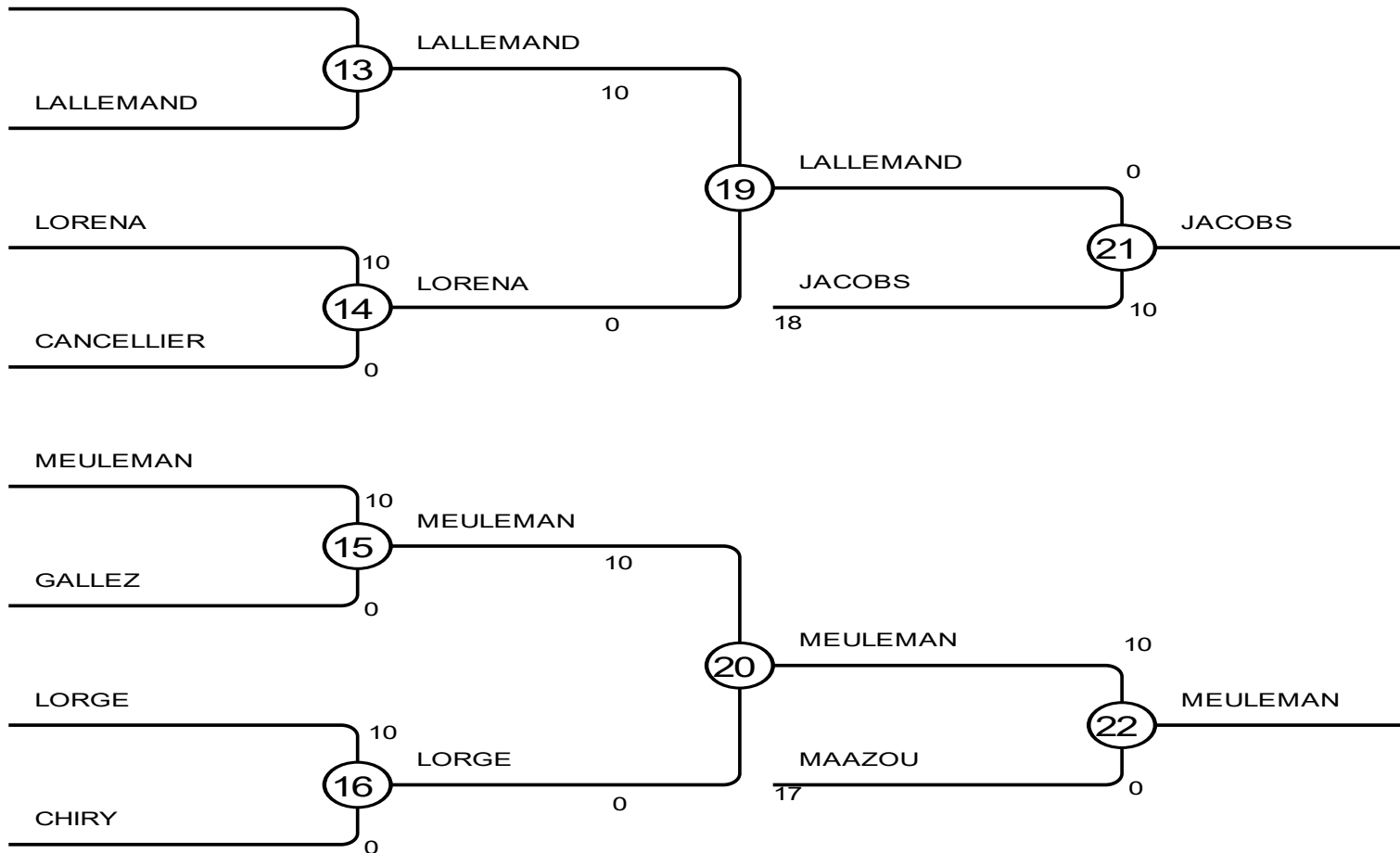

# FSUB Judo Championship 13/12/2023 H-73

Competitors: 15

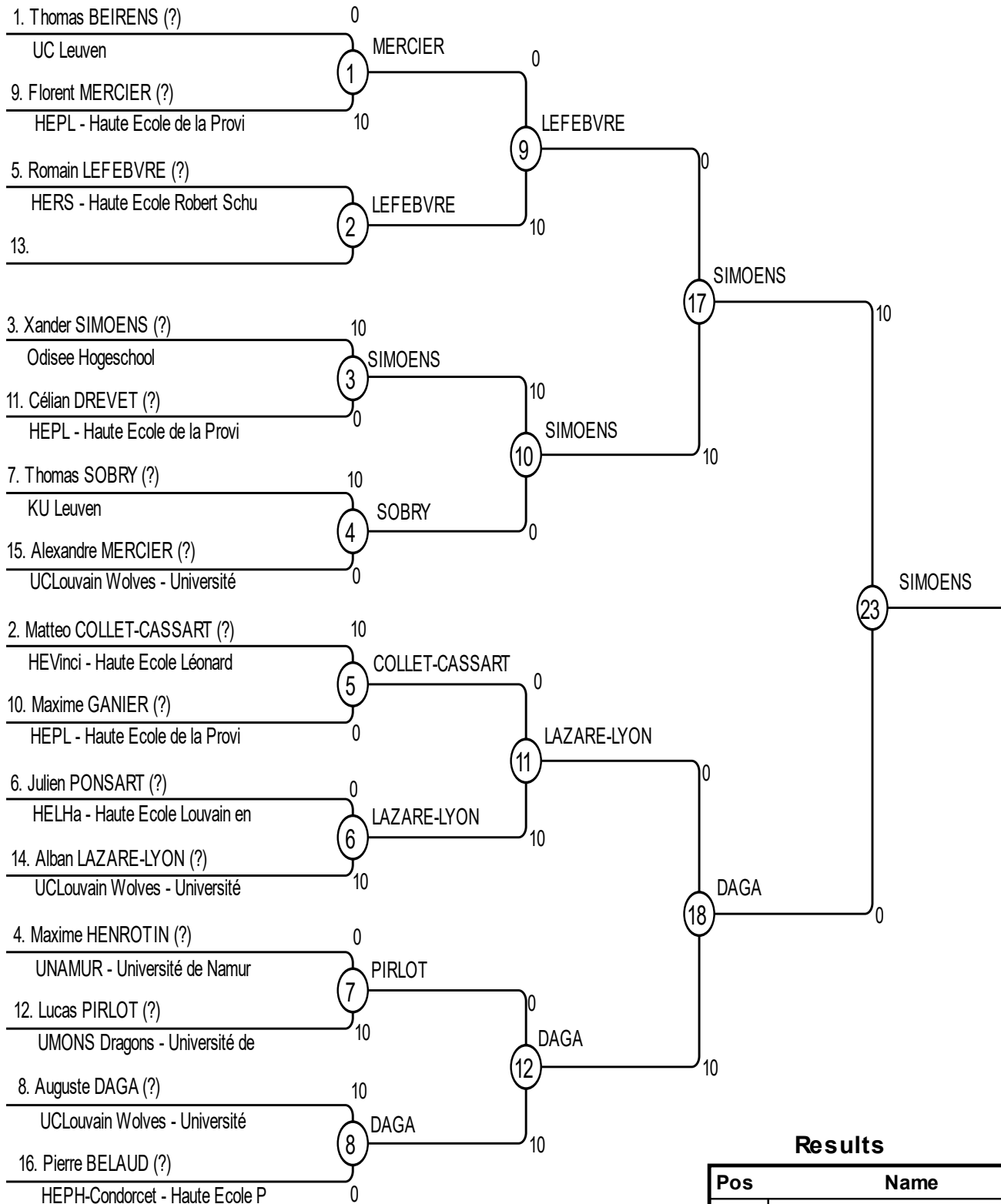

## Results

Pos	Name
1	Xander SIMOENS Odisee Hogeschool
2	Auguste DAGA UCLouvain Wolves - Univer
3	Florent MERCIER HEPL - Haute Ecole de
3	Pierre BELAUD HEPH-Condorcet - Haute
5	Alban LAZARE-LYON UCLouvain Wolves -
5	Romain LEFEBVRE HERS - Haute Ecole F
7	Thomas SOBRY KU Leuven
7	Matteo COLLET-CASSART HEVinci - Haut

B.U.S.F. - F.S.U.B.







# FSUB Judo Championship 13/12/2023 H-81

B.U.S.F. - F.S.U.B.



Competitors: 8

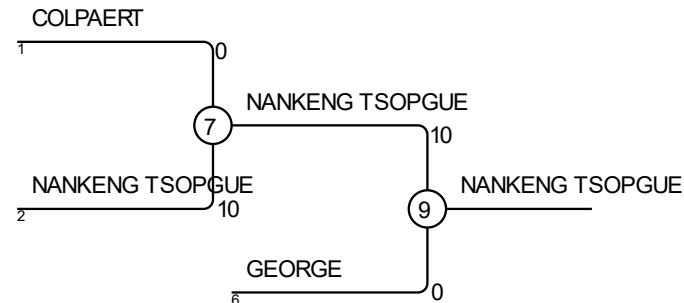
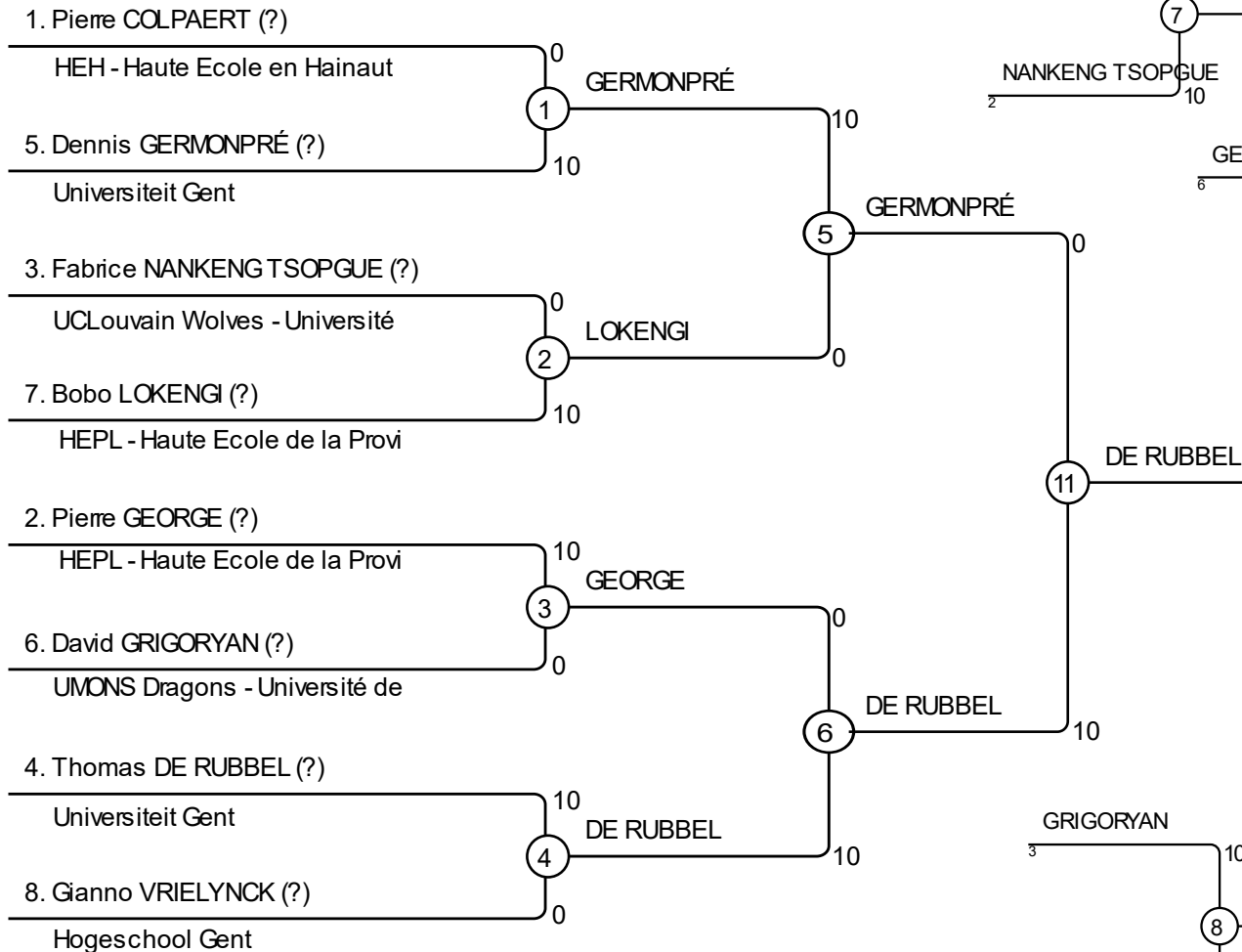

## Results

Pos	Name
1	Thomas DE RUBBEL Universiteit Gent
2	Dennis GERMONPRÉ Universiteit Gent
3	Fabrice NANKENGTSOPGUE UCLouvain Wolves -
3	Bobo LOKENGI HEPL - Haute Ecole de la Provi
5	Pierre GEORGE HEPL - Haute Ecole de la Provi
5	David GRIGORYAN UMONS Dragons - Université de
7	Pierre COLPAERT HEH - Haute Ecole en Hainaut
7	Gianni VRIELYNCK Hogeschool Gent

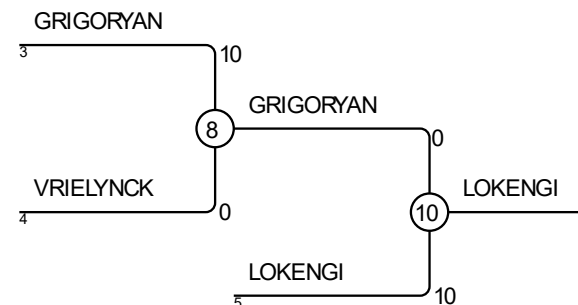

# FSUB Judo Championship 13/12/2023 H-90

Competitors: 3

## Competitors

#	Name	Club	1	2	3	Wins	Pts	Pos
1	Dokka GURZHIKHANOV (?) UCLouvain Wolves - Université			10	0	1	10	2
2	Thomas PLATEAU (?) HELHa - Haute Ecole Louvain en		0		0	0	0	3
3	Warre VAN HASSELT (?) Thomas More Kempen		10	10		2	20	1

## Matches

Match	White	Blue	Result	Time
1	Dokka GURZHIKHANOV 1 2	Thomas PLATEAU	10 - 0	
2	Dokka GURZHIKHANOV 1 3	Warre VAN HASSELT	0 - 10	
3	Thomas PLATEAU 2 3	Warre VAN HASSELT	0 - 10	

## Results

Pos	Name
1	Warre VAN HASSELT Thomas More Kempen
2	Dokka GURZHIKHANOV UCLouvain Wolves - Université
3	Thomas PLATEAU HELHa - Haute Ecole Louvain en

B.U.S.F. - F.S.U.B.



# FSUB Judo Championship 13/12/2023 H-100

Competitors: 4

## Competitors

#	Name	Club	1	2	3	4	Wins	Pts	Pos
1	Soufiane AL AYACHI (?) UCLouvain Wolves - Université			10	0	10	2	20	1
2	Olivier DELEFORTRIE (?) UCLouvain Wolves - Université		0		10	10	2	20	2
3	Augustin BRANDI (?) HELHa - Haute Ecole Louvain en		10	0		0	1	10	4
4	Erwan VERSTRAETE (?) HEPL - Haute Ecole de la Provi		0	0	10		1	10	3

## Matches

Match	White			Blue	Result	Time
1	Soufiane AL AYACHI	1	2	Olivier DELEFORTRIE	10 - 0	
2	Augustin BRANDI	3	4	Erwan VERSTRAETE	0 - 10	
3	Soufiane AL AYACHI	1	3	Augustin BRANDI	0 - 10	
4	Olivier DELEFORTRIE	2	4	Erwan VERSTRAETE	10 - 0	
5	Soufiane AL AYACHI	1	4	Erwan VERSTRAETE	10 - 0	
6	Olivier DELEFORTRIE	2	3	Augustin BRANDI	10 - 0	

## Results

Pos	Name
1	Soufiane AL AYACHI UCLouvain Wolves - Université
2	Olivier DELEFORTRIE UCLouvain Wolves - Université
3	Erwan VERSTRAETE HEPL - Haute Ecole de la Provi
4	Augustin BRANDI HELHa - Haute Ecole Louvain en

B.U.S.F. - F.S.U.B.



Résultats du Championnat FSUB  
de Judo par équipe  
Salle de l'UMONS  
Mercredi 13 mars 2024



FSUB Judo Teams Championship 2024

TAPIS

1

P1

	Equipe	1	2	3	4	5	Points	VE	VI	DE	DI	Place
1	AAS. KU Leuven 2		1 5 51	0 3 30			1	8	81	8	80	2
2	ULiège	0 3 30		0 0 0			0	3	30	12	121	3
3	AUGent	1 5 50	1 7 70				2	12	120	3	30	1
4							0	0	0	0	0	
5							0	0	0	0	0	

Poule de 3 : 1/2 2/3 1/3

Poule de 4 : 1/2 3/4 1/3 2/4 1/4 2/3

Poule de 5 : 1/2 3/4 1/5 2/4 3/5 1/4 2/3 4/5 1/3 2/5

FSUB Judo Teams Championship 2024

TAPIS

2

P2

	Equipe	1	2	3	4	5	Points	VE	VI	DE	DI	Place
1	ASS. KU Leuven 1		1 7 61	1 6 60			2	13	121	3	21	1
2	HELHa	0 1 1		0 3 30			0	4	31	11	92	3
3	UCLouvain Wolves	0 2 20	1 4 31				1	6	51	9	90	2
4							0	0	0	0	0	
5							0	0	0	0	0	

Poule de 3 : 1/2 2/3 1/3

Poule de 4 : 1/2 3/4 1/3 2/4 1/4 2/3

Poule de 5 : 1/2 3/4 1/5 2/4 3/5 1/4 2/3 4/5 1/3 2/5

**FSUB Judo Teams Championship 2024 - Finales**

**Finales**

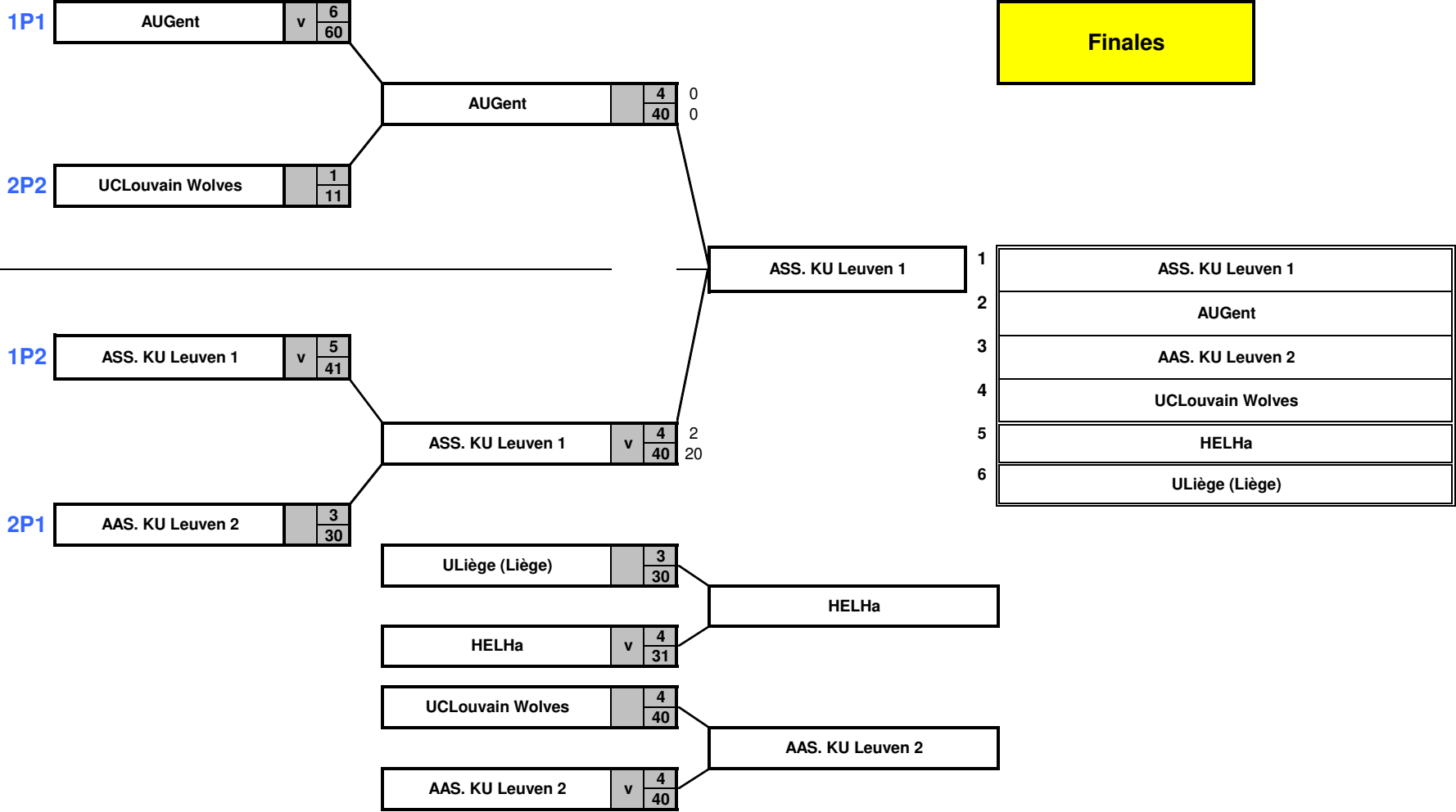



# Résultats du Championnat FSUB de Natation

Piscine de Groenenhoek- Anvers

Mardi 16 avril 2024



Belgisch Studentenkampioenschap Zwemmen 2024  
Groenenhoek Berchem, 16/4/2024

1 - dinsdag 16 april 2024

16/04/2024 - 15:00

Programmanr. 1 Dames, 100m vrije slag open leeftijdsgroep  
16/04/2024 Resultaten

Rang			Inschr.	Tijd
1.	GHELEYNS, Juliette	UCLouvain	59.90	<b>1:01.12</b>
2.	VANDERSCHRICK, Laura	UGent	59.88	<b>1:01.31</b>
3.	BERTHET, Lana	HEVinci	1:00.91	<b>1:01.90</b>
4.	THIRY, Emma	UCLouvain	1:03.00	<b>1:01.92</b>
5.	DAEMEN, Sien	KU Leuven	1:00.00	<b>1:02.01</b>
6.	KEUNEN, Kyara	ERM-KMS	1:03.00	<b>1:06.32</b>
7.	VAN OLMEN, Jill	KU Leuven	1:06.00	<b>1:08.31</b>
8.	BLOTHIAUX, Aline	UCLouvain	1:06.00	<b>1:09.28</b>
9.	OTTEVAERE, Roxanne	KU Leuven	1:11.27	<b>1:11.71</b>
10.	SCHREDER, Ines	HEPL	1:08.45	<b>1:12.08</b>
11.	TAHAY, Elise	ULB	1:13.00	<b>1:12.58</b>
12.	PARENT, Elise	ERM-KMS	1:15.00	<b>1:13.23</b>
FF	FENDLER, Coline	FF HEPL	1:06.43	

Programmanr. 2 Heren, 100m vrije slag open leeftijdsgroep  
16/04/2024 Resultaten

Rang			Inschr.	Tijd
1.	VANDERSCHRICK, Stephan	Howest	51.59	<b>52.35</b>
2.	MORIAU, Thibault	UCLouvain	52.53	<b>53.60</b>
3.	CAMPS, Roeland	KU Leuven	53.90	<b>54.14</b>
4.	VANDENDORPE, Emile	UGent	55.90	<b>55.78</b>
5.	RESTIAU, Robbe	UGent	55.00	<b>55.80</b>
6.	DENISON, Antoine	UCLouvain	53.96	<b>56.20</b>
7.	KYRIAKIDES, Niels	UAntwerpen	54.00	<b>56.82</b>
8.	DA CONCEICAO, Luis	ULB	55.34	<b>56.94</b>
9.	LEMAN, Arnaud	HELHa	57.15	<b>57.84</b>
10.	ENGLEBERT, Antoine	HEVinci	59.19	<b>58.04</b>
11.	LONCOUR, Briec	UCLouvain	1:00.00	<b>59.76</b>
12.	JANSSENS, Florian	HEVinci	1:00.00	<b>1:00.24</b>
13.	DUTHOIT, Quintin	ERM-KMS	1:00.00	<b>1:02.80</b>
14.	GUILLAUME, Maxime	HEVinci	1:03.00	<b>1:03.00</b>
15.	DEPREZ, Lander	KU Leuven	1:00.00	<b>1:04.56</b>
16.	MANIER, Enzo	HELHa	1:15.30	<b>1:04.77</b>
17.	LEVELING, Nicolas	ULB	1:22.09	<b>1:04.98</b>
18.	LAMBERT, Yann	ERM-KMS	59.00	<b>1:05.15</b>
19.	DEFLOOR, Jules	KU Leuven	57.00	<b>1:06.14</b>
20.	VANCANNEYT, Matthias	ERM-KMS	1:08.00	<b>1:06.90</b>
21.	DUPONT, Nathan	ULB	1:12.51	<b>1:07.28</b>
22.	COLIN, Martin	HEPL	1:07.12	<b>1:07.79</b>
23.	VOITOUT, Andreas	HELHa	2:00.00	<b>1:13.90</b>
24.	DE LIÈGE, Maxime	HEPL	1:14.03	<b>1:15.80</b>
FF	BURY, Jérémie	FF HEPL	1:01.34	

Belgisch Studentenkampioenschap Zwemmen 2024  
Groenenhoek Berchem, 16/4/2024

Programmanr. 3 Dames, 100m schoolslag open leeftijdsgroep  
16/04/2024 Resultaten

Rang		Inschr.	Tijd
1.	VIANE, Perla UGent	1:13.19	<b>1:16.68</b>
2.	BORREMANS, Lotte UGent	1:15.47	<b>1:18.66</b>
3.	BÖSELER, Natasja AP	1:19.03	<b>1:20.63</b>
4.	ELIARD, Tania UCLouvain	1:24.00	<b>1:22.46</b>
5.	LEMAL, Alice UCLouvain St.-Lo1	1:23.76	<b>1:24.10</b>
6.	LEMAITRE, Elona UCLouvain	1:27.00	<b>1:24.52</b>
7.	SEBILLE, Chloé HELHa	1:23.47	<b>1:25.71</b>
8.	BOSH, Claire KU Leuven	1:22.58	<b>1:28.06</b>
9.	COPPIN, Emilie KU Leuven	1:32.36	<b>1:30.34</b>
10.	KLEIN, Célia ERM-KMS	1:33.00	<b>1:36.03</b>
11.	SIMONET, Victoria UCLouvain	1:30.00	<b>1:40.58</b>
12.	GIESBERTS, Mirte KU Leuven	1:40.00	<b>1:42.94</b>

Programmanr. 4 Heren, 100m schoolslag open leeftijdsgroep  
16/04/2024 Resultaten

Rang		Inschr.	Tijd
1.	SIBILLA, Matteo UCLouvain	1:03.17	<b>1:04.49</b>
2.	VANDENDORPE, Emile UGent	1:06.47	<b>1:07.50</b>
3.	ABBEEL, Stef UGent	1:13.07	<b>1:09.12</b>
4.	SEYMOUR, Felix HEVinci	1:08.32	<b>1:10.39</b>
5.	ALIX, Axel UCLouvain	1:12.00	<b>1:12.12</b>
6.	VANDERHULST, Tobe KU Leuven	1:09.76	<b>1:13.93</b>
7.	HERMAN, Aidan UGent	1:12.00	<b>1:13.94</b>
8.	GREGOIRE, Juan UCLouvain	1:13.00	<b>1:14.76</b>
9.	KADOU, Chadi ULB	1:13.62	<b>1:16.15</b>
10.	CLAES, Yannick KU Leuven	1:15.00	<b>1:16.91</b>
11.	THEUNIS, Stan KU Leuven	1:14.00	<b>1:18.76</b>
12.	RICKER, Adrien HEPL	1:39.87	<b>1:20.06</b>
13.	LABY, Nicolas ERM-KMS	1:25.00	<b>1:20.07</b>
14.	SAIDI, Yassin UAntwerpen	1:15.00	<b>1:20.30</b>
15.	RACHIDI, Nizar ULB	NT	<b>1:33.30</b>
16.	DROUIN, Thibault ULB	1:46.47	<b>1:37.06</b>
17.	DE SAINT-GEORGES, Oscar HEPL	1:58.02	<b>1:45.76</b>

Programmanr. 5 Dames, 200m wisselslag open leeftijdsgroep  
16/04/2024 Resultaten

Rang		Inschr.	Tijd
1.	BORREMANS, Lotte UGent	2:31.95	<b>2:33.88</b>
2.	VAN LEERSUM, Amy KU Leuven	2:36.26	<b>2:38.52</b>
	DAEMEN, Sien KU Leuven	2:33.00	<b>2:38.52</b>
4.	PAREIJN, Luna KU Leuven	2:32.00	<b>2:45.80</b>
5.	VINCK, Lore UGent	2:47.82	<b>2:48.69</b>
6.	JANVIER, Zoé ULB	2:50.00	<b>2:54.88</b>
7.	PATRY, Anne UCLouvain	3:00.00	<b>3:08.28</b>
FF	GARAGNA, Gemma FF ULB	3:10.00	



Belgisch Studentenkampioenschap Zwemmen 2024  
Groenenhoek Berchem, 16/4/2024

Programmanr. 9 Dames, 50m schoolslag open leeftijdsgroep  
16/04/2024 Resultaten

Rang			Inschr.	Tijd
1.	GHELEYNS, Juliette	UCLouvain	33.50	<b>34.87</b>
2.	VIANE, Perla	UGent	34.30	<b>35.66</b>
3.	SEMPELS, Aurélie	KU Leuven	37.51	<b>36.85</b>
4.	BÖSELER, Natasja	AP	36.00	<b>36.86</b>
5.	VAVRITSKA, Victoria	UGent	34.69	<b>37.59</b>
	GORIS, Resy	KU Leuven	36.30	<b>37.59</b>
7.	ELIARD, Tania	UCLouvain	36.00	<b>38.00</b>
8.	LEMAL, Alice	UCLouvain St.-Loui	39.24	<b>39.68</b>
9.	BOSH, Claire	KU Leuven	37.51	<b>39.86</b>
10.	DELARUELLE, Camille	HELHa	38.34	<b>39.90</b>
11.	WATTIAUX, Julie	UMONS	38.18	<b>40.76</b>
12.	LAMOTTE, Sarah	UAntwerpen	42.00	<b>41.80</b>
13.	KLEIN, Célia	ERM-KMS	41.00	<b>42.64</b>
14.	CIMINO, Emmy	HEPL	45.23	<b>44.76</b>
15.	SIMONET, Victoria	UCLouvain	40.00	<b>44.84</b>
16.	COURNEGOUL, Ophélie	HEPL	55.32	<b>48.38</b>
17.	LAUWAET, Margot	HEPL	42.21	<b>50.54</b>
dis	PARENT, Elise	dis	ERM-KMS	43.00
	<i>SW 4.4 - valse start</i>			
dis	VANDEWAL, Fien	dis	ERM-KMS	40.00
	<i>SW 4.4 - valse start</i>			

Programmanr. 10 Heren, 200m schoolslag open leeftijdsgroep  
16/04/2024 Resultaten

Rang			Inschr.	Tijd
1.	TANGHE, Kasper	UGent	2:30.00	<b>2:25.03</b>
2.	CLAESEN, Tijs	KU Leuven	2:36.44	<b>2:36.44</b>
3.	STAVART, Corentin	UCLouvain	2:45.00	<b>2:42.45</b>
4.	HOUTEVELT, Kyllian	ULB	2:37.78	<b>2:44.11</b>
5.	ENGLEBERT, Antoine	HEVinci	2:50.00	<b>2:44.38</b>
6.	VAN BOXSTAEL, Jan	KU Leuven	2:40.00	<b>2:54.18</b>
7.	RICKER, Adrien	HEPL	2:48.67	<b>2:57.88</b>
8.	LABY, Nicolas	ERM-KMS	3:10.00	<b>2:59.14</b>
9.	VAN LOOCK, Stijn	KU Leuven	2:59.42	<b>3:02.10</b>
10.	DROUIN, Thibault	ULB	3:41.56	<b>3:32.64</b>
11.	DE SAINT-GEORGES, Oscar	HEPL	2:58.84	<b>3:55.39</b>

Programmanr. 11 Dames, 100m vlinderslag open leeftijdsgroep  
16/04/2024 Resultaten

Rang			Inschr.	Tijd
1.	TOMCSIK, Kira	KU Leuven	1:04.23	<b>1:06.04</b>
2.	BOGAERTS, Aïsha	KU Leuven	1:05.07	<b>1:07.80</b>
3.	LANIER, Suzanne	UCLouvain	1:11.50	<b>1:13.45</b>
4.	VERSTAPPEN, Emma	KU Leuven	1:20.00	<b>1:15.12</b>

Belgisch Studentenkampioenschap Zwemmen 2024  
Groenenhoek Berchem, 16/4/2024

Programmanr. 12 Heren, 100m vlinderslag open leeftijdsgroep  
16/04/2024 Resultaten

Rang			Inschr.	Tijd
1.	MORIAU, Thibault	UCLouvain	56.22	<b>57.20</b>
2.	SWILLEN, Timon	KU Leuven	58.30	<b>57.80</b>
	VANDAMME, Hugo	HEPH-CONDORCE	55.39	<b>57.80</b>
4.	GILET, Mathis	ULB	1:01.56	<b>1:01.30</b>
5.	VAN HENTENRIJK, Matthieu	ULB	59.23	<b>1:02.34</b>
6.	PELGRIMS-RENS, Yorben	ERM-KMS	1:04.00	<b>1:04.43</b>
	DUGARDIN, Gaucelin	UCLouvain	1:07.00	<b>1:04.43</b>
8.	DUFAYS, Louis	HE2B	NT	<b>1:04.90</b>
9.	CLAESSENS, Noah	HEPL	1:05.71	<b>1:05.76</b>
10.	CAUCHIE, Hugo	UCLouvain	59.00	<b>1:06.32</b>
11.	SPRUYT, Linus	KU Leuven	1:10.00	<b>1:11.07</b>
12.	DE WAEGENEER, Brent	ERM-KMS	1:09.00	<b>1:11.68</b>
13.	LEVELING, Nicolas	ULB	1:16.77	<b>1:12.58</b>
14.	DUTHOIT, Quintin	ERM-KMS	1:12.00	<b>1:12.92</b>
15.	LUNGU, Teodor	HEVinci	1:14.00	<b>1:15.14</b>
16.	DE ZUTTER, Jason	KU Leuven	1:18.00	<b>1:17.37</b>

Programmanr. 13 Dames, 50m vrije slag open leeftijdsgroep  
16/04/2024 Resultaten

Rang			Inschr.	Tijd
1.	DUMONT, Juliette	UCLouvain	28.50	<b>27.90</b>
2.	COETS, Shannon	UCLouvain	27.70	<b>27.98</b>
3.	THIRY, Emma	UCLouvain	28.50	<b>28.34</b>
4.	WATELLE, Anna	KU Leuven	28.09	<b>28.62</b>
5.	VAVRITSKA, Victoria	UGent	28.64	<b>28.68</b>
6.	VAN LEERSUM, Amy	KU Leuven	28.00	<b>29.08</b>
7.	DRUEZ, Lena	UMONS	28.08	<b>29.82</b>
8.	PEETERS, Birthe	KU Leuven	28.80	<b>30.05</b>
	KEUNEN, Kyara	ERM-KMS	29.00	<b>30.05</b>
10.	ONGENAE, Anneleen	Howest	29.36	<b>30.58</b>
11.	VINCK, Lore	UGent	30.50	<b>31.32</b>
12.	WATTIAUX, Julie	UMONS	30.21	<b>31.81</b>
13.	EVRARD, Jeanne	HEVinci	34.00	<b>32.14</b>
14.	JANVIER, Zoé	ULB	31.50	<b>32.25</b>
15.	VANDEWAL, Fien	ERM-KMS	33.00	<b>32.65</b>
16.	DELARUELLE, Camille	HELHa	31.35	<b>32.82</b>
17.	TAHAY, Elise	ULB	34.00	<b>33.66</b>
18.	JAKIEWICZ, Justine	UMONS	32.90	<b>36.10</b>
19.	REUSSE, Emma	ULB	39.00	<b>37.38</b>
20.	BOULANGER, Victorine	HEPL	32.01	<b>38.10</b>
21.	HOLDERBEKE, Charlotte	HEPL	32.36	<b>40.26</b>
22.	BEAVOGUI, Angéline	ULiège	1:30.00	<b>1:03.78</b>
FF	FENDLER, Coline	FF HEPL	31.23	

Belgisch Studentenkampioenschap Zwemmen 2024  
Groenenhoek Berchem, 16/4/2024

Programmanr. 14 Heren, 200m vrije slag open leeftijdsgroep  
16/04/2024 Resultaten

Rang			Inschr.	Tijd
1.	VANDERSCHRICK, Stephan	Howest	1:55.80	<b>1:55.76</b>
2.	LISSOIR, Colin	UCLouvain	1:53.00	<b>1:56.17</b>
3.	SEYMOUR, Felix	HEVinci	2:00.54	<b>2:03.45</b>
4.	LEROUX, Wout	UGent	2:00.98	<b>2:03.64</b>
5.	VERBEEK, Bram	KU Leuven	2:02.70	<b>2:08.56</b>
6.	TOGBAG, Sami	ULB	2:02.14	<b>2:08.86</b>
7.	LEMAN, Arnaud	HELHa	2:05.17	<b>2:10.19</b>
8.	HOUTEVELT, Kyllian	ULB	2:10.71	<b>2:11.80</b>
9.	PELGRIMS-RENS, Yorben	ERM-KMS	2:05.00	<b>2:11.88</b>
10.	LONCOUR, Briec	UCLouvain	2:12.00	<b>2:15.14</b>
11.	FRISON, Seppe	KU Leuven	2:24.16	<b>2:17.96</b>
12.	CAUCHIE, Hugo	UCLouvain	2:02.00	<b>2:18.11</b>
13.	GUILLAUME, Maxime	HEVinci	2:15.00	<b>2:18.50</b>
14.	DEKIMPE, Dries	KU Leuven	2:30.00	<b>2:31.88</b>
15.	HALLEUX, Guillaume	ERM-KMS	2:30.00	<b>2:33.70</b>
FF	JANSSENS, Louis	FF ULB	2:32.50	

Programmanr. 15 Dames, 50m rugslag open leeftijdsgroep  
16/04/2024 Resultaten

Rang			Inschr.	Tijd
1.	VANDERSCHRICK, Laura	UGent	31.50	<b>31.36</b>
2.	DEMEYERE, Anouk	Howest	31.05	<b>31.64</b>
3.	VERBEEK, Britt	KU Leuven	35.00	<b>33.91</b>
4.	LAMOTTE, Sarah	UAntwerpen	38.00	<b>35.81</b>
5.	DUBOIS, Zoé	UCLouvain	34.00	<b>35.95</b>
6.	DOM, Elize	KU Leuven	35.00	<b>36.46</b>
7.	EVRARD, Jeanne	HEVinci	37.00	<b>37.82</b>
8.	HENDRICK, Lena	HEPL	38.72	<b>38.08</b>
9.	VANKEVELAER, Nele	KU Leuven	39.00	<b>38.81</b>
10.	BLOTHIAUX, Aline	UCLouvain	34.70	<b>39.42</b>
11.	WILLAYE, Lola	UMONS	40.67	<b>41.96</b>
12.	JAJKIEWICZ, Justine	UMONS	40.30	<b>42.68</b>
13.	CIMINO, Emmy	HEPL	37.56	<b>42.82</b>
14.	BOULANGER, Victorine	HEPL	41.70	<b>43.78</b>
dis	BEAVOGUI, Angéline	dis ULiège	1:10.00	

*SW 10.2 - Niet de volledige afstand gezwommen*

Programmanr. 16 Heren, 200m rugslag open leeftijdsgroep  
16/04/2024 Resultaten

Rang			Inschr.	Tijd
1.	BALHAUT, Augustin	UCLouvain	2:07.00	<b>2:18.30</b>
2.	DA CONCEICAO, Luis	ULB	2:20.82	<b>2:21.80</b>
3.	STAVART, Corentin	UCLouvain	2:20.00	<b>2:28.40</b>
4.	LIMBIOUL, Thomas	ERM-KMS	2:25.00	<b>2:30.23</b>
5.	VERBEEK, Mats	KU Leuven	2:30.00	<b>2:30.86</b>

Belgisch Studentenkampioenschap Zwemmen 2024  
Groenenhoek Berchem, 16/4/2024

Programmanr. 17 Dames, 50m vlinderslag open leeftijdsgroep  
16/04/2024 Resultaten

Rang		Inschr.	Tijd	
1.	DUMONT, Juliette	UCLouvain	30.50	<b>30.04</b>
2.	TOMCSIK, Kira	KU Leuven	28.70	<b>30.05</b>
3.	BERTHET, Lana	HEVinci	29.36	<b>30.32</b>
4.	DANIÉLS, Lise	Artevelde	29.72	<b>30.62</b>
5.	BROSENS, Sarah	KU Leuven	31.80	<b>31.46</b>
	DRUEZ, Lena	UMONS	30.14	<b>31.46</b>
7.	CORNELISSEN, Dali	KU Leuven	29.60	<b>31.95</b>
8.	SEBILLE, Chloé	HELHa	32.47	<b>32.81</b>
9.	GARAGNA, Gemma	ULB	40.00	<b>32.92</b>
10.	ONGENAE, Anneleen	Howest	31.41	<b>33.45</b>
11.	LEMAITRE, Elona	UCLouvain	40.50	<b>35.68</b>
12.	SCHREDER, Ines	HEPL	38.32	<b>35.98</b>
13.	HENDRICK, Lena	HEPL	37.23	<b>36.24</b>
	BOU KHALED, Yasmina	ULB	36.81	<b>36.24</b>
15.	PATRY, Anne	UCLouvain	38.00	<b>39.92</b>
16.	WILLAYE, Lola	UMONS	38.99	<b>41.78</b>
17.	COURNEGOUL, Ophélie	HEPL	55.32	<b>44.35</b>

Programmanr. 18 Heren, 50m vrije slag open leeftijdsgroep  
16/04/2024 Resultaten

Rang		Inschr.	Tijd	
1.	DO, Duy Thang Tanguy	UCLouvain	24.30	<b>23.49</b>
2.	BERGES, Jens	UAntwerpen	24.50	<b>24.46</b>
3.	LUST, Louis	UGent	24.50	<b>24.78</b>
4.	ABBEEL, Stef	UGent	25.40	<b>25.08</b>
5.	ALIX, Axel	UCLouvain	25.50	<b>25.15</b>
6.	KYRIAKIDES, Niels	UAntwerpen	24.30	<b>25.30</b>
7.	CAMPS, Viktor	KU Leuven	24.95	<b>25.33</b>
	DENISON, Antoine	UCLouvain	24.90	<b>25.33</b>
9.	VANDAMME, Hugo	HEPH-CONDORCE	24.06	<b>25.52</b>
10.	VERBEEK, Bram	KU Leuven	24.50	<b>25.65</b>
11.	DELISSEN, Mats	KU Leuven	25.50	<b>25.78</b>
12.	TOGBAG, Sami	ULB	24.55	<b>25.96</b>
13.	DUFAYS, Louis	HE2B	26.50	<b>26.02</b>
14.	SAIDI, Yassin	UAntwerpen	27.50	<b>27.75</b>
	JANSSENS, Florian	HEVinci	27.00	<b>27.75</b>
16.	VANCANNEYT, Matthias	ERM-KMS	27.00	<b>28.84</b>
17.	VAN RIJSWIJCK, Vic	ERM-KMS	28.00	<b>28.86</b>
	COLIN, Martin	HEPL	31.23	<b>28.86</b>
19.	LAMBERT, Yann	ERM-KMS	27.00	<b>28.91</b>
20.	MANIER, Enzo	HELHa	31.20	<b>29.10</b>
21.	DUPONT, Nathan	ULB	31.06	<b>29.86</b>
22.	LUNGU, Teodor	HEVinci	28.00	<b>30.14</b>
23.	VOITOUT, Andreas	HELHa	50.00	<b>30.87</b>
24.	DE LIÈGE, Maxime	HEPL	33.02	<b>31.40</b>
25.	VAN ISEGHEM, Matias	ULB	31.81	<b>31.54</b>
26.	KOZLOW, Victor	HEPL	32.12	<b>33.18</b>



Belgisch Studentenkampioenschap Zwemmen 2024  
Groenenhoek Berchem, 16/4/2024

Programmanr. 19 Dames, 4 x 50m wisselslag open leeftijdsgroep  
16/04/2024 Resultaten

Rang			Inshr.	Tijd
1.	UCLouvain 2	UCLouvain	NT	<b>2:05.47</b>
	,	,		
	,	,		
2.	KU Leuven 1	KU Leuven	NT	<b>2:08.95</b>
	,	,		
	,	,		
3.	UGent 1	UGent	NT	<b>2:09.16</b>
	,	,		
	,	,		
4.	KU Leuven 2	KU Leuven	NT	<b>2:16.13</b>
	,	,		
	,	,		
5.	UCLouvain 1	UCLouvain	NT	<b>2:19.25</b>
	,	,		
	,	,		
6.	ERM-KMS 1	ERM-KMS	NT	<b>2:28.49</b>
	,	,		
	,	,		
7.	UMONS 1	UMONS	NT	<b>2:34.25</b>
	,	,		
	,	,		
8.	ULB 1	ULB	NT	<b>2:35.98</b>
	,	,		
	,	,		

Programmanr. 20 Heren, 4 x 50m wisselslag open leeftijdsgroep  
16/04/2024 Resultaten

Rang			Inshr.	Tijd
1.	KU Leuven 1	KU Leuven	NT	<b>1:46.98</b>
	,	,		
	,	,		
2.	UCLouvain 1	UCLouvain	NT	<b>1:48.57</b>
	,	,		
	,	,		
3.	ULB 1	ULB	NT	<b>1:52.89</b>
	,	,		
	,	,		
4.	UCLouvain 2	UCLouvain	NT	<b>1:56.79</b>
	,	,		
	,	,		
5.	KU Leuven 2	KU Leuven	NT	<b>1:57.88</b>
	,	,		
	,	,		
6.	HEVinci 1	HEVinci	NT	<b>2:02.12</b>
	,	,		
	,	,		
7.	ERM-KMS 1	ERM-KMS	NT	<b>2:06.52</b>
	,	,		
	,	,		

Belgisch Studentenkampioenschap Zwemmen 2024  
Groenenhoek Berchem, 16/4/2024

Programmanr. 20, Heren, 4 x 50m wisselslag, open leeftijdsgroep

Rang			Inshr.	Tijd
8.	ULB 2	ULB	NT	<b>2:18.12</b>
	,	,		
	,	,		
dis	UGent 1	dis UGent	NT	
	<i>SW 10.12 - Te vroeg gestart in een aflossing door 2de, 3de of 4de zwemmer</i>			
	'' '' ''			

Programmanr. 21  
16/04/2024

Dames, 4 x 50m vrije slag

open leeftijdsgroep  
Resultaten

Rang			Inshr.	Tijd
1.	UCLouvain 1	UCLouvain	NT	<b>1:52.60</b>
	,	,		
	,	,		
2.	KU Leuven 2	KU Leuven	NT	<b>1:53.78</b>
	,	,		
	,	,		
3.	UGent 1	UGent	NT	<b>1:55.43</b>
	,	,		
	,	,		
4.	KU Leuven 1	KU Leuven	NT	<b>2:00.82</b>
	,	,		
	,	,		
5.	UCLouvain 2	UCLouvain	NT	<b>2:02.92</b>
	,	,		
	,	,		
6.	ERM-KMS 1	ERM-KMS	NT	<b>2:09.82</b>
	,	,		
	,	,		
7.	ULB 1	ULB	NT	<b>2:15.78</b>
	,	,		
	,	,		
8.	UMONS 1	UMONS	NT	<b>2:18.15</b>
	,	,		
	,	,		
9.	HEPL 1	HEPL	NT	<b>2:28.28</b>
	,	,		
	,	,		

Programmanr. 22  
16/04/2024

Heren, 4 x 50m vrije slag

open leeftijdsgroep  
Resultaten

Rang			Inshr.	Tijd
------	--	--	--------	------

Belgisch Studentenkampioenschap Zwemmen 2024  
Groenenhoek Berchem, 16/4/2024

Programmanr. 22, Heren, 4 x 50m vrije slag

1. UGent	UGent	NT	<b>1:39.02</b>
,	,		
,	,		
2. UCLouvain 1	UCLouvain	NT	<b>1:39.24</b>
,	,		
,	,		
3. KU Leuven 1	KU Leuven	NT	<b>1:39.89</b>
,	,		
,	,		
4. ULB 2	ULB	NT	<b>1:41.80</b>
,	,		
,	,		
5. UCLouvain 2	UCLouvain	NT	<b>1:43.01</b>
,	,		
,	,		
6. KU Leuven 2	KU Leuven	NT	<b>1:47.70</b>
,	,		
,	,		
7. ERM-KMS 1	ERM-KMS	NT	<b>1:50.19</b>
,	,		
,	,		
HEVinci 1	HEVinci	NT	<b>1:50.19</b>
,	,		
,	,		
9. ERM-KMS 2	ERM-KMS	NT	<b>1:54.93</b>
,	,		
,	,		
10. ULB 1	ULB	NT	<b>2:02.32</b>
,	,		
,	,		
11. HEPL 1	HEPL	NT	<b>2:06.00</b>
,	,		
,	,		

Programmanr. 23  
16/04/2024

Gemengd, 10 x 50m vrije slag

open leeftijdsgroep  
Resultaten

Rang		Inshr.	Tijd
1.	KU Leuven 1	NT	<b>4:22.59</b>
	,		
	,		
	,		
	,		
	,		
2.	UGent 1	NT	<b>4:22.94</b>
	,		
	,		
	,		
	,		
	,		
3.	UCLouvain 1	NT	<b>4:26.76</b>
	,		
	,		
	,		
	,		
	,		

Belgisch Studentenkampioenschap Zwemmen 2024  
Groenenhoek Berchem, 16/4/2024

Programmanr. 23, Gemengd, 10 x 50m vrije slag, open leeftijdsgroep

Rang			Inshr.	Tijd
4.	ERM-KMS 1	ERM-KMS	NT	<b>4:51.91</b>
	,	,		
	,	,		
	,	,		
	,	,		
	,	,		
5.	UCLouvain 2	UCLouvain	NT	<b>4:55.92</b>
	,	,		
	,	,		
	,	,		
	,	,		
	,	,		
6.	KU Leuven 2	KU Leuven	NT	<b>4:56.00</b>
	,	,		
	,	,		
	,	,		
	,	,		
	,	,		
7.	ULB 1	ULB	NT	<b>5:19.31</b>
	,	,		
	,	,		
	,	,		
	,	,		
	,	,		
8.	HEPL 1	HEPL	NT	<b>5:45.00</b>
	,	,		
	,	,		
	,	,		
	,	,		
	,	,		
dis	KU Leuven	dis KU Leuven	NT	<b>4:54.41</b>
	<i>CODE - codes versie 2024v1, update 21dec23</i>			
	,	,		
	,	,		
	,	,		
	,	,		
	,	,		
dis	KU Leuven	dis KU Leuven	NT	<b>5:02.68</b>
	<i>CODE - codes versie 2024v1, update 21dec23</i>			
	,	,		
	,	,		
	,	,		
	,	,		
	,	,		

Alle, open leeftijdsgroep

1. UCLouvain	UCLouvain	280,00
2. KU Leuven	KU LEUVEN	241,00
3. Universiteit Gent	UGENT	172,00
4. Université libre de Bruxelles	ULB	78,00
5. Hogeschool West Vlaanderen	HOWEST	48,00
6. Haute École Léonard de Vinci	HEVINCI	42,00
7. Universiteit Antwerpen	UANTWERPEN	36,00
8. Ecole Royale Militaire - Koninklijke Militaire School	ERM-KMS	31,00
9. AP Hogeschool Antwerpen	AP	15,00
10. Haute École Louvain en Hainaut	HELHA	14,00
11. Haute École Provinciale de Hainaut - Condorcet	HEPH-CONDO	12,00
Haute École de la Province de Liège	HEPL	12,00
13. Université de Mons	UMONS	10,00
14. UCLouvain Saint-Louis - Bruxelles	UCLouvain	9,00
15. Arteveldehogeschool	ARTEVELDE	7,00
16. Haute-École Bruxelles-Brabant	HE2B	3,00
17. Université de Liège	ULIÈGE	-
Vrije Universiteit Brussel	VUB	-

Alle, open leeftijdsgroep

1. UCLouvain

UCLouvain 280,00

1. GHELEYNS, Juliette	1. Dames, 100m vrije slag	1:01.12	12,00
4. THIRY, Emma	1. Dames, 100m vrije slag	1:01.92	7,00
8. BLOTHIAUX, Aline	1. Dames, 100m vrije slag	1:09.28	3,00
2. MORIAU, Thibault	2. Heren, 100m vrije slag	53.60	10,00
6. DENISON, Antoine	2. Heren, 100m vrije slag	56.20	5,00
4. ELIARD, Tania	3. Dames, 100m schoolslag	1:22.46	7,00
6. LEMAITRE, Elona	3. Dames, 100m schoolslag	1:24.52	5,00
1. SIBILLA, Matteo	4. Heren, 100m schoolslag	1:04.49	12,00
5. ALIX, Axel	4. Heren, 100m schoolslag	1:12.12	6,00
8. GREGOIRE, Juan	4. Heren, 100m schoolslag	1:14.76	3,00
7. PATRY, Anne	5. Dames, 200m wisselslag	3:08.28	4,00
1. LISSOIR, Colin	6. Heren, 200m wisselslag	2:10.97	12,00
8. GREMILLIER, Mathis	6. Heren, 200m wisselslag	2:44.65	3,00
2. COETS, Shannon	7. Dames, 100m rugslag	1:08.80	10,00
3. LANIER, Suzanne	7. Dames, 100m rugslag	1:11.81	8,00
6. DUBOIS, Zoé	7. Dames, 100m rugslag	1:19.50	5,00
3. DO, Duy Thang Tanguy	8. Heren, 100m rugslag	1:00.01	8,00
4. BALHAUT, Augustin	8. Heren, 100m rugslag	1:00.99	7,00
10. GREMILLIER, Mathis	8. Heren, 100m rugslag	1:15.70	1,00
1. GHELEYNS, Juliette	9. Dames, 50m schoolslag	34.87	12,00
7. ELIARD, Tania	9. Dames, 50m schoolslag	38.00	4,00
3. STAVART, Corentin	10. Heren, 200m schoolslag	2:42.45	8,00
3. LANIER, Suzanne	11. Dames, 100m vlinderslag	1:13.45	8,00
1. MORIAU, Thibault	12. Heren, 100m vlinderslag	57.20	12,00
6. DUGARDIN, Gaucefin	12. Heren, 100m vlinderslag	1:04.43	5,00
10. CAUCHIE, Hugo	12. Heren, 100m vlinderslag	1:06.32	1,00
1. DUMONT, Juliette	13. Dames, 50m vrije slag	27.90	12,00
2. COETS, Shannon	13. Dames, 50m vrije slag	27.98	10,00
3. THIRY, Emma	13. Dames, 50m vrije slag	28.34	8,00
2. LISSOIR, Colin	14. Heren, 200m vrije slag	1:56.17	10,00
10. LONCOUR, Brieuc	14. Heren, 200m vrije slag	2:15.14	1,00
5. DUBOIS, Zoé	15. Dames, 50m rugslag	35.95	6,00
10. BLOTHIAUX, Aline	15. Dames, 50m rugslag	39.42	1,00
1. BALHAUT, Augustin	16. Heren, 200m rugslag	2:18.30	12,00
3. STAVART, Corentin	16. Heren, 200m rugslag	2:28.40	8,00
1. DUMONT, Juliette	17. Dames, 50m vlinderslag	30.04	12,00
1. DO, Duy Thang Tanguy	18. Heren, 50m vrije slag	23.49	12,00
5. ALIX, Axel	18. Heren, 50m vrije slag	25.15	6,00
7. DENISON, Antoine	18. Heren, 50m vrije slag	25.33	4,00

2. KU Leuven

KU LEUVEN 241,00

5. DAEMEN, Sien	1. Dames, 100m vrije slag	1:02.01	6,00
7. VAN OLMEN, Jill	1. Dames, 100m vrije slag	1:08.31	4,00
9. OTTEVAERE, Roxanne	1. Dames, 100m vrije slag	1:11.71	2,00
3. CAMPS, Roeland	2. Heren, 100m vrije slag	54.14	8,00
8. BOSH, Claire	3. Dames, 100m schoolslag	1:28.06	3,00
9. COPPIN, Emilie	3. Dames, 100m schoolslag	1:30.34	2,00
6. VANDERHULST, Tobe	4. Heren, 100m schoolslag	1:13.93	5,00
10. CLAES, Yannick	4. Heren, 100m schoolslag	1:16.91	1,00
2. VAN LEERSUM, Amy	5. Dames, 200m wisselslag	2:38.52	10,00
2. DAEMEN, Sien	5. Dames, 200m wisselslag	2:38.52	10,00
4. PAREIJN, Luna	5. Dames, 200m wisselslag	2:45.80	7,00
2. SWILLEN, Timon	6. Heren, 200m wisselslag	2:11.04	10,00
6. MAROZAS, Kajus	6. Heren, 200m wisselslag	2:32.86	5,00
7. NIETO RODRIGUEZ, Alexand	6. Heren, 200m wisselslag	2:36.52	4,00
4. BOGAERTS, Aisha	7. Dames, 100m rugslag	1:13.90	7,00
5. PAREIJN, Luna	7. Dames, 100m rugslag	1:14.04	6,00
7. OTTEVAERE, Charlotte	7. Dames, 100m rugslag	1:21.46	4,00
6. CAMPS, Roeland	8. Heren, 100m rugslag	1:03.14	5,00
8. VERBEEK, Mats	8. Heren, 100m rugslag	1:06.94	3,00
3. SEMPELS, Aurélie	9. Dames, 50m schoolslag	36.85	8,00
5. GORIS, Resy	9. Dames, 50m schoolslag	37.59	6,00
9. BOSH, Claire	9. Dames, 50m schoolslag	39.86	2,00
2. CLAESEN, Tijs	10. Heren, 200m schoolslag	2:36.44	10,00
6. VAN BOXSTAEL, Jan	10. Heren, 200m schoolslag	2:54.18	5,00
9. VAN LOOCK, Stijn	10. Heren, 200m schoolslag	3:02.10	2,00
1. TOMCSIK, Kira	11. Dames, 100m vlinderslag	1:06.04	12,00
2. BOGAERTS, Aisha	11. Dames, 100m vlinderslag	1:07.80	10,00
4. VERSTAPPEN, Emma	11. Dames, 100m vlinderslag	1:15.12	7,00
2. SWILLEN, Timon	12. Heren, 100m vlinderslag	57.80	10,00
4. WATELLE, Anna	13. Dames, 50m vrije slag	28.62	7,00
6. VAN LEERSUM, Amy	13. Dames, 50m vrije slag	29.08	5,00
8. PEETERS, Birthe	13. Dames, 50m vrije slag	30.05	3,00
5. VERBEEK, Bram	14. Heren, 200m vrije slag	2:08.56	6,00
3. VERBEEK, Britt	15. Dames, 50m rugslag	33.91	8,00
6. DOM, Elize	15. Dames, 50m rugslag	36.46	5,00
9. VANKEVELAER, Nele	15. Dames, 50m rugslag	38.81	2,00
5. VERBEEK, Mats	16. Heren, 200m rugslag	2:30.86	6,00
2. TOMCSIK, Kira	17. Dames, 50m vlinderslag	30.05	10,00
5. BROSENS, Sarah	17. Dames, 50m vlinderslag	31.46	6,00
7. CORNELISSEN, Dali	17. Dames, 50m vlinderslag	31.95	4,00
7. CAMPS, Viktor	18. Heren, 50m vrije slag	25.33	4,00
10. VERBEEK, Bram	18. Heren, 50m vrije slag	25.65	1,00

**Belgisch Studentenkampioenschap Zwemmen 2024**  
Groenenhoek Berchem, 16/4/2024

**3. Universiteit Gent**

		<b>UGENT</b>	<b>172,00</b>
2. VANDERSCHRICK, Laura	1. Dames, 100m vrije slag	1:01.31	10,00
4. VANDENDORPE, Emile	2. Heren, 100m vrije slag	55.78	7,00
5. RESTIAU, Robbe	2. Heren, 100m vrije slag	55.80	6,00
1. VIANE, Perla	3. Dames, 100m schoolslag	1:16.68	12,00
2. BORREMANS, Lotte	3. Dames, 100m schoolslag	1:18.66	10,00
2. VANDENDORPE, Emile	4. Heren, 100m schoolslag	1:07.50	10,00
3. ABBEEL, Stef	4. Heren, 100m schoolslag	1:09.12	8,00
7. HERMAN, Aidan	4. Heren, 100m schoolslag	1:13.94	4,00
1. BORREMANS, Lotte	5. Dames, 200m wisselslag	2:33.88	12,00
5. VINCK, Lore	5. Dames, 200m wisselslag	2:48.69	6,00
3. TANGHE, Kasper	6. Heren, 200m wisselslag	2:17.78	8,00
4. HERMAN, Aidan	6. Heren, 200m wisselslag	2:23.89	7,00
7. RESTIAU, Robbe	8. Heren, 100m rugslag	1:05.39	4,00
2. VIANE, Perla	9. Dames, 50m schoolslag	35.66	10,00
5. VAVRITSKA, Victoria	9. Dames, 50m schoolslag	37.59	6,00
1. TANGHE, Kasper	10. Heren, 200m schoolslag	2:25.03	12,00
5. VAVRITSKA, Victoria	13. Dames, 50m vrije slag	28.68	6,00
4. LEROUX, Wout	14. Heren, 200m vrije slag	2:03.64	7,00
1. VANDERSCHRICK, Laura	15. Dames, 50m rugslag	31.36	12,00
3. LUST, Louis	18. Heren, 50m vrije slag	24.78	8,00
4. ABBEEL, Stef	18. Heren, 50m vrije slag	25.08	7,00

**4. Université libre de Bruxelles**

		<b>ULB</b>	<b>78,00</b>
8. DA CONCEICAO, Luis	2. Heren, 100m vrije slag	56.94	3,00
9. KADOU, Chadi	4. Heren, 100m schoolslag	1:16.15	2,00
6. JANVIER, Zoé	5. Dames, 200m wisselslag	2:54.88	5,00
5. KADOU, Chadi	6. Heren, 200m wisselslag	2:32.22	6,00
8. REUSSE, Emma	7. Dames, 100m rugslag	1:33.99	3,00
1. GILET, Mathis	8. Heren, 100m rugslag	58.08	12,00
5. VAN HENTENRIJK, Matthieu	8. Heren, 100m rugslag	1:02.09	6,00
4. HOUTEVELT, Kyllian	10. Heren, 200m schoolslag	2:44.11	7,00
10. DROUIN, Thibault	10. Heren, 200m schoolslag	3:32.64	1,00
4. GILET, Mathis	12. Heren, 100m vliederslag	1:01.30	7,00
5. VAN HENTENRIJK, Matthieu	12. Heren, 100m vliederslag	1:02.34	6,00
6. TOGBAG, Sami	14. Heren, 200m vrije slag	2:08.86	5,00
8. HOUTEVELT, Kyllian	14. Heren, 200m vrije slag	2:11.80	3,00
2. DA CONCEICAO, Luis	16. Heren, 200m rugslag	2:21.80	10,00
9. GARAGNA, Gemma	17. Dames, 50m vliederslag	32.92	2,00

**5. Hogeschool West Vlaanderen**

		<b>HOWEST</b>	<b>48,00</b>
1. VANDERSCHRICK, Stephan	2. Heren, 100m vrije slag	52.35	12,00
1. DEMEYERE, Anouk	7. Dames, 100m rugslag	1:08.29	12,00
10. ONGENAE, Anneleen	13. Dames, 50m vrije slag	30.58	1,00
1. VANDERSCHRICK, Stephan	14. Heren, 200m vrije slag	1:55.76	12,00
2. DEMEYERE, Anouk	15. Dames, 50m rugslag	31.64	10,00
10. ONGENAE, Anneleen	17. Dames, 50m vliederslag	33.45	1,00

**6. Haute École Léonard de Vinci**

		<b>HEVINCI</b>	<b>42,00</b>
3. BERTHET, Lana	1. Dames, 100m vrije slag	1:01.90	8,00
10. ENGLEBERT, Antoine	2. Heren, 100m vrije slag	58.04	1,00
4. SEYMOUR, Felix	4. Heren, 100m schoolslag	1:10.39	7,00
5. ENGLEBERT, Antoine	10. Heren, 200m schoolslag	2:44.38	6,00
3. SEYMOUR, Felix	14. Heren, 200m vrije slag	2:03.45	8,00
7. EVRARD, Jeanne	15. Dames, 50m rugslag	37.82	4,00
3. BERTHET, Lana	17. Dames, 50m vliederslag	30.32	8,00

**7. Universiteit Antwerpen**

		<b>UANTWERPEN</b>	<b>36,00</b>
7. KYRIAKIDES, Niels	2. Heren, 100m vrije slag	56.82	4,00
2. BERGES, Jens	8. Heren, 100m rugslag	58.62	10,00
4. LAMOTTE, Sarah	15. Dames, 50m rugslag	35.81	7,00
2. BERGES, Jens	18. Heren, 50m vrije slag	24.46	10,00
6. KYRIAKIDES, Niels	18. Heren, 50m vrije slag	25.30	5,00

**8. Ecole Royale Militaire - Koninklijke Militaire School**

		<b>ERM-KMS</b>	<b>31,00</b>
6. KEUNEN, Kyara	1. Dames, 100m vrije slag	1:06.32	5,00
10. KLEIN, Célia	3. Dames, 100m schoolslag	1:36.03	1,00
9. DE WAEGENEER, Brent	6. Heren, 200m wisselslag	2:47.54	2,00
10. HALLEUX, Guillaume	6. Heren, 200m wisselslag	2:50.32	1,00
9. LIMBIOUL, Thomas	8. Heren, 100m rugslag	1:09.08	2,00
8. LABY, Nicolas	10. Heren, 200m schoolslag	2:59.14	3,00
6. PELGRIMS-RENS, Yorben	12. Heren, 100m vliederslag	1:04.43	5,00
8. KEUNEN, Kyara	13. Dames, 50m vrije slag	30.05	3,00
9. PELGRIMS-RENS, Yorben	14. Heren, 200m vrije slag	2:11.88	2,00
4. LIMBIOUL, Thomas	16. Heren, 200m rugslag	2:30.23	7,00

**9. AP Hogeschool Antwerpen**

		<b>AP</b>	<b>15,00</b>
3. BÖSELER, Natasja	3. Dames, 100m schoolslag	1:20.63	8,00
4. BÖSELER, Natasja	9. Dames, 50m schoolslag	36.86	7,00

**10. Haute École Louvain en Hainaut**

		<b>HELHA</b>	<b>14,00</b>
9. LEMAN, Arnaud	2. Heren, 100m vrije slag	57.84	2,00
7. SEBILLE, Chloé	3. Dames, 100m schoolslag	1:25.71	4,00
10. DELARUELLE, Camille	9. Dames, 50m schoolslag	39.90	1,00
7. LEMAN, Arnaud	14. Heren, 200m vrije slag	2:10.19	4,00
8. SEBILLE, Chloé	17. Dames, 50m vliederslag	32.81	3,00

**11. Haute École Provinciale de Hainaut - Condorcet**

		<b>HEPH-CONDO</b>	<b>12,00</b>
2. VANDAMME, Hugo	12. Heren, 100m vliederslag	57.80	10,00
9. VANDAMME, Hugo	18. Heren, 50m vrije slag	25.52	2,00

Belgisch Studentenkampioenschap Zwemmen 2024  
Groenenhoek Berchem, 16/4/2024

---

<b>Haute École de la Province de Liège</b>		<b>HEPL</b>	<b>12,00</b>
10. SCHREDER, Ines	1. Dames, 100m vrije slag	1:12.08	1,00
9. LAUWAET, Margot	7. Dames, 100m rugslag	1:40.85	2,00
7. RICKER, Adrien	10. Heren, 200m schoolslag	2:57.88	4,00
9. CLAESSENS, Noah	12. Heren, 100m vlinderslag	1:05.76	2,00
8. HENDRICK, Lena	15. Dames, 50m rugslag	38.08	3,00
<b>13. Université de Mons</b>		<b>UMONS</b>	<b>10,00</b>
7. DRUEZ, Lena	13. Dames, 50m vrije slag	29.82	4,00
5. DRUEZ, Lena	17. Dames, 50m vlinderslag	31.46	6,00
<b>14. UCLouvain Saint-Louis - Bruxelles</b>		<b>UCLouvain</b>	<b>9,00</b>
5. LEMAL, Alice	3. Dames, 100m schoolslag	1:24.10	6,00
8. LEMAL, Alice	9. Dames, 50m schoolslag	39.68	3,00
<b>15. Arteveldehogeschool</b>		<b>ARTEVELDE</b>	<b>7,00</b>
4. DANIÉLS, Lise	17. Dames, 50m vlinderslag	30.62	7,00
<b>16. Haute-École Bruxelles-Brabant</b>		<b>HE2B</b>	<b>3,00</b>
8. DUFAYS, Louis	12. Heren, 100m vlinderslag	1:04.90	3,00
<b>17. Université de Liège</b>		<b>ULIÈGE</b>	<b>-</b>
<b>Vrije Universiteit Brussel</b>		<b>VUB</b>	<b>-</b>



# QUALIFICATIONS



## Speelschema BSK: Padel Heren reeks A 29/nov/23

Locatie: Universitair sportcentrum KU Leuven - Tervuursevest 101 - Heverlee

Aanmelden: Topsporthal KU Leuven  
Wedstrijdduur: 2 sets tot 6 met supertie break tot 10  
Volgende ronde: 2 beste teams per poule plaatsen zich voor de finaleronde op 23/04/24

	Poule 1		Veld 4		Poule 2		Veld 5		Poule 3		Veld 2		Poule 4		Veld 2	
<b>A</b>	Denis	Nees	1400	KU Leuven	Fol	Verbesselt	1400	KU Leuven	Sermant	Vandelanotte	1500	AUGent	Vanhauwe	Vanhauwe	1400	UGent
<b>B</b>	Daem	Diels	1100	KU Leuven	El Bachaoui	Bertels	1000	KU Leuven	Tardy	Callens	1200	ULB Owls	Olieslagers	Dewulf	1000	KU Leuven
<b>C</b>	Azou	Vandewalle	1200	AHS	Willermain	Gasparon	1000	KU Leuven	Paepens	Aneca	1400	AUGent	De Vylder	Oeyen	1700	AUHA
<b>D</b>	Sweerman	De Smedt	1200	HOGENT	Priem	Lariviere	1400	KU Leuven								

Heren reeks A												
Timing	Poule 1	Uitslag		Poule 2	Uitslag		Poule 3	Uitslag		Poule 4	Uitslag	
11u	A-B	6-3	6-1	A-B	6-0	6-0	A-B	6-0	6-4	A-B	6-0	6-0
12u	C-D	6-3	6-7 10-4	C-D		FFT						
13u	A-C	6-1	6-2	A-C		FFT	B-C	6-3	6-3			
14u	B-D	7-6	6-4	B-D	6-0	6-4				B-C	6-2	6-0
15u	A-D	7-5	6-3	A-D	6-3	6-4	A-C	7-5	4-6 10-8			
16u	B-C	6-4	5-7 11-9	B-C		FFT				A-C	6-2	6-0

### Ranking

	Poule 1			Scores	Poule 2			Scores	Poule 3			Scores	Poule 4			Scores
1	Denis	Nees	KU Leuven	9	Fol	Verbesselt	KU Leuven	9	Sermant	Vandelanotte	AUGent	6	Vanhauwe	Vanhauwe	UGent	6
2	Daem	Diels	KU Leuven	6	Priem	Lariviere	KU Leuven	6	Tardy	Callens	ULB Owls	3	De Vylder	Oeyen	AUHA	3
3	Sweerman	De Smedt	HOGENT	0	El Bachaoui	Bertels	KU Leuven	3	Paepens	Aneca	AUGent	0	Olieslagers	Dewulf	KU Leuven	0
4	Azou	Vandewalle	KU Leuven -AHS	Deelname buiten klassement	Willermain	Gasparon	KU Leuven	FFT								

### Finaleronde

	Poule 1			Poule 2			Poule 3			Poule 4		
<b>A</b>	Denis	Nees	KU Leuven	Fol	Verbesselt	KU Leuven	Sermant	Vandelanotte	AUGent	Vanhauwe	Vanhauwe	UGent
<b>B</b>	Daem	Diels	KU Leuven	Priem	Lariviere	KU Leuven	Tardy	Callens	ULB Owls	De Vylder	Oeyen	AUHA



## Speelschema BSK: Padel Heren reeks B/Dames

29/nov/23

Locatie: Universitair sportcentrum KU Leuven - Tervuursevest 101 - Heverlee

Aanmelden: Topsporthal KU Leuven  
 Wedstrijdduur: 2 sets tot 6 met supertie break tot 10  
 Volgende ronde: 2 beste teams per poule plaatsen zich voor de finaleronde op 23/04/24

	Poule 1	Veld 1			Poule 2	Veld 3		
<b>A</b>	Eduard Barro Fernandez	Miguel Prats Garrido	900	KU Leuven	Neyens	Brandt	800	HE Vinci
<b>B</b>	Degrootte	Dewasme	800	HE Vinci	Walbers	Verheyden	900	KU Leuven
<b>C</b>	Grey	Mehanna	?	KU Leuven	Mateo Dubrovský	Iñigo	800	KU Leuven
<b>D</b>	Fabré	Fauche	800	KU Leuven	Smets	Smeets	800	KU Leuven

Heren reeks B/dames					
Timing	Poule 1	Uitslag	Poule 2	Uitslag	
11u	<b>A-B</b>	FFT	<b>A-B</b>	6-4	7-6
12u	<b>C-D</b>	6-0 6-2	<b>C-D</b>	6-0	6-0
13u	<b>A-C</b>	6-3 6-2	<b>A-C</b>	6-1	6-0
14u	<b>B-D</b>	6-4 6-1	<b>B-D</b>	6-0	6-4
15u	<b>A-D</b>	6-4 6-2	<b>A-D</b>	7-5	6-1
16u	<b>B-C</b>	6-4 5-7 10-4	<b>B-C</b>	6-1	6-1

### Ranking

	Poule 1			Scores	Poule 2			Scores
<b>1</b>	Grey	Mehanna	KU Leuven	9	Walbers	Verheyden	KU Leuven	9
<b>2</b>	Fabré	Fauche	KU Leuven	6	Neyens	Brandt	HE Vinci	6
<b>3</b>	Eduard Barro	Miguel Prats	KU Leuven	3	Smets	Smeets	KU Leuven	3
<b>4</b>	Fernandez	Garrido	HE Vinci	0	Mateo Dubrovský	Iñigo	KU Leuven	0

**Finaleronde**

	Poule 1			Poule 2		
<b>A</b>	Grey	Mehanna	KU Leuven	Walbers	Verheyden	KU Leuven
	Eduard Barro	Miguel Prats				
<b>B</b>	Fernandez	Garrido	KU Leuven	Neyens	Brandt	HE Vinci

**Dames Finale**

Team 1			Team 2		
Fabré	Fauche	KU Leuven	Smets	Smeets	KU Leuven

# FINALES



## Speelschema BSK: Padel Heren A/ Heren B/Dames 23/apr/24

Locatie: Sportcampus Arenberg KU Leuven - Tervuursevest 101 - Heverlee

Aanmelden: Topsportthal KU Leuven  
Wedstrijdduur: 2 sets tot 6 met supertie break tot 10

### HEREN A

	QF 1		QF 2		QF 3		QF 4					
	Veld 4		Veld 2		Veld 5		Veld 3					
A	Denis	Nees	KU Leuven	Fol	Verbesselt	KU Leuven	Sermant	Vandelanotte	AUGent	<b>Vanhauwe</b>	<b>Vanhauwe</b>	UGent
B				Tardy	Callens	ULB Owls			KU Leuven	Priem	Diels	KU Leuven

	SF 1		SF 2	
	Veld 4		Veld 2	
	Score		Score	
A	Denis	Nees	Sermant	Vandelanotte
B	Tardy	Callens	<b>Vanhauwe</b>	<b>Vanhauwe</b>
	4-6; 7-6; 10-6		6-2; 6-3	

	Finale		Kleine finale	
	Veld 4		Veld 2	
	Score		Score	
A	Denis	Nees	Tardy	Callens
B	<b>Vanhauwe</b>	<b>Vanhauwe</b>	Sermant	Vandelanotte
	6-4; 6-3		6-1; 6-2	

### HEREN B

	SF 1		SF 2	
	Veld 2		Veld 4	
A	Grey	Mehanna	Walbers	Devries
B	Ross	Brandt	Eduard Barro	Miguel Prats
	KU Leuven		KU Leuven	
	HE Vinci		KU Leuven	

	Finale		Kleine finale	
	Veld 4		Veld 5	
	Score		Score	
A	Ross	Brandt	Grey	Mehanna
B	Walbers	Devries	Eduard Barro	Miguel Prats
	6-1; 6-3		FFT	
			Fernandez Garrido	

**DAMES**

		Finale		Veld 2		Score
A	Fabré	Fauche	KU Leuven			6-1 ; 6-3
B	Smets	Smeets	KU Leuven			

Wedstrijdschema Heren A - Heren B - Dames								
Timing	Veld 4		Veld 2		Veld 5		Veld 3	
	QF 1	Uitslag	QF 2	Uitslag	QF 3	Uitslag	QF 4	Uitslag
12u	A-B	FFT	A-B	6-3; 1-6; 10-6	A-B	FFT	A-B	6-4; 6-2
14u	SF 1	4-6; 7-6; 10-6	SF 2	6-2; 6-3	SF 2	FFT	SF 1	6-3 6-2
	A-B		A-B		A-B			
15u	Finale	6-1 6-3	Finale	6-1 6-3	Kleine finale	FFT		
	A-B		A-B		A-B			
16u	Finale	6-4 6-3	Kleine finale	6-1 6-2				
	A-B		A-B		A-B			

## Championnat FSUB Rugby VII : 26-10-23 au Kituro

HOMMES- Poule A			HOMMES- Poule B		
Institutions	Points	GA	Institutions	Points	GA
HEPL	6	-7	HE Vinci 2	0	-25
ULB Owls	3	33	UCLouvain Wolves	6	39
HE Vinci 1	9	58	UGent	3	-4
KU Leuven	0	-84			

DAMES		
Institutions	Points	GA
UCLouvain Wolves	6	-3
HEPL	6	-22
ULB Owls	10	35
HE Vinci	6	14
KU Leuven	1	-21



### Terrain 1

	Heure	Poule	Domicile	Score		Extérieur	Arbitre
M1	10h40	Hommes	ULB Owls	12	19	HE Vinci 1	Sach
M2	11h00	Hommes	HE Vinci 2	5	33	UCLouvain Wolves	Mat
M3	11h20	Dames	HE Vinci	10	14	UCLouvain Wolves	Geo
M4	11h40	Dames	HEPL	26	7	KU Leuven	Do
M5	12h00	Hommes	KU Leuven	21	33	HEPL	Sach
M6	12h20	Hommes	UCLouvain Wolves	28	17	UGent	Do
M7	12h40	Dames	UCLouvain Wolves	10	12	ULB Owls	Geo
M8	13h00	Dames	KU Leuven	12	15	HE Vinci	Mat
M9	13h20	Hommes	HEPL	5	31	HE Vinci 1	Sach
M10	13h40	Hommes	ULB Owls	47	0	KU Leuven	Mat
M11	14h00	Hommes	UGent	28	21	HE Vinci 2	Do
M12	14h20	Dames	HE Vinci	22	0	HEPL	Nath
M13	14h40	Dames	ULB Owls	15	15	KU Leuven	Sach
M14	15h00	Hommes	HEPL	19	12	ULB Owls	Nath
M15	15h20	Hommes	HE Vinci 1	25	0	KU Leuven	Do

### Terrain 1

	Heure	Poule	Domicile	Score		Extérieur	Arbitre
M16	15h40	Dames	KU Leuven	10	12	UCLouvain Wolves	Mat
M17	16h00	Dames	HEPL	0	26	ULB Owls	Sach
M18	16h20	Hommes	ULB Owls	45	5	HE Vinci 2	Mat
M19- 1/2 finale	16h40	Hommes	HE Vinci 1	40	0	UGent	N - D - M
M20- 1/2 finale	17h00	Hommes	UCLouvain Wolves	17	7	HEPL	S - D - N
M21	17h20	Dames	UCLouvain Wolves	19	26	HEPL	Do
M22	17h40	Dames	ULB Owls	7	0	HE Vinci	Nath
M23- Consolation	18h00	Hommes	UGent	25 - 0 (Fft HEPL)		HEPL	D - S - N
M24- Finale	18h20	Hommes	HE Vinci 1	28	5	UCLouvain Wolves	M - S - N

### Classement Hommes

- 1 - HE Vinci 1
- 2 - UCLouvain Wolves
- 3 - Ugent
- 4 - HEPL
- 5 - ULB Owls
- 6 - HE Vinci 2
- 7 - KU Leuven

### Classement Dames

- 1 - ULB Owls
- 2 - HE Vinci
- 3 - UCLouvain Wolves
- 4 - HEPL
- 5 - KU Leuven

### Abréviat\* Arbitres

<b>SACH</b>	Sacha De Neyer
<b>MAT</b>	Mathieu Walravens
<b>JOHN</b>	John Catteau
<b>GEO</b>	Geoffrey Serralbo
<b>DO</b>	Dorian Delhaut
<b>NATH</b>	Nathanaël Legras

### Calcul Classement

- 1) Points
- 2) Cartes rouges
- 3) Goal Average
- 4) Cartes jaunes
- 5) Tirage au sort

# Résultats du championnat FSUB

## Tennis de Table

Cuesmes

28/10/2023



Poule 1 Dame A+B+C			
Noms	Club	CL	Pos
Renuart Marion	HE2B	A	1
Dufau Claire	Uliège (liège)	B6	3
Bousrez Nell	HELHa	C0	2

Joueur 1	Joueur 2	Arbitre	Score	
Renuart Marion	Bousrez Nell	Dufau Claire	3	0
Dufau Claire	Bousrez Nell	Renuart Marion	1	3
Renuart Marion	Dufau Claire	Bousrez Nell	2	3

Poule 2 Dame A+B+C			
Noms	Club	CL	Pos
Colot Elea	HELHa	B0	1
Brico Marine	UCLouvain Wolves	B2	2
Vermeiren Cilia	EPHEC	C4	4
Masson Catherine	HELHa	C4	3

Joueur 1	Joueur 2	Arbitre	Score	
Colot Elea	Masson Catherine	Vermeiren Cilia	3	1
Brico Marine	Vermeiren Cilia	Colot Elea	2	3
Colot Elea	Vermeiren Cilia	Brico Marine	3	0
Brico Marine	Masson Catherine	Colot Elea	3	0
Colot Elea	Brico Marine	Masson Catherine	2	3
Vermeiren Cilia	Masson Catherine	Brico Marine	0	3



# Tournoi inter universitaire Série: Dame A+B+C

1/4

1/2

Finale

1	Renuart Marion HE2B	A	1
8			
5			
4	Brico Marine UCLouvain Wolves	B2	1
3	Bousrez Nell HELHa	C0	1
6			
7			
2	Colot Elea HELHa	B0	1

Renuart Marion HE2B	
Brico Marine UCLouvain Wolves	2
Brico Marine UCLouvain Wolves	3
Bousrez Nell HELHa	
Bousrez Nell HELHa	1
Colot Elea HELHa	3

Brico Marine UCLouvain Wolves	
Colot Elea HELHa	

3	1	Brico Marine UCLouvain Wolves B2
2	2	Colot Elea HELHa B0
3	3	Bousrez Nell HELHa C0
4	4	Renuart Marion HE2B A

Petite finale

Renuart Marion HE2B	0
Bousrez Nell HELHa	3

Poule 1 Dame D+NC			
Noms	Club	CL	Pos
DOSIMONT Maeva	HELHa	D0	1
Debaisieux Tania	UMONS Dragon	D4	2
Noirhomme Laure	ULB Owls	D6	3
Lara Balmori Arosa	ULB Owls	NC	4
Vanderelst Mélanie	UMONS Dragon	NC	5

Joueur 1	Joueur 2	Arbitre	Score	
DOSIMONT Maeva	Vanderelst Mélanie	Debaisieux Tania	3	0
Debaisieux Tania	Lara Balmori Arosa	Noirhomme Laure	3	2
DOSIMONT Maeva	Lara Balmori Arosa	Vanderelst Mélanie	3	0
Debaisieux Tania	Noirhomme Laure	DOSIMONT Maeva	3	0
DOSIMONT Maeva	Noirhomme Laure	Lara Balmori Arosa	3	0
Lara Balmori Arosa	Vanderelst Mélanie	Debaisieux Tania	3	1
Debaisieux Tania	Vanderelst Mélanie	DOSIMONT Maeva	3	0
Noirhomme Laure	Lara Balmori Arosa	Vanderelst Mélanie	3	0
DOSIMONT Maeva	Debaisieux Tania	Noirhomme Laure	3	1
Noirhomme Laure	Vanderelst Mélanie	Lara Balmori Arosa	3	2

### Tournoi inter universitaire dame D+ NC

Poule 1	Noms	Cl	classement
1	DOSIMONT Maeva	D0	1 er
2	Debaisieux Tania	D4	2 éme
3	Noirhomme Laure	D6	3 éme
4	Lara Balmori Arosa	NC	4 éme
5	Vanderelst Mélanie	NC	5 éme

**Le gagnant rapporte le papier au Juge-Arbitre et est responsable du résultat.**

N° match	Rencontre	Arbitre
1	1-5	2
2	2-4	3
3	1-4	5
4	2-3	1
5	1-3	4
6	4-5	2
7	2-5	1
8	3-4	5
9	1-2	3
10	3-5	4

Poule 1 Homme A+B			
Noms	Club	CL	Pos
Di Pietro Noah	UCLouvain Wolves	B0	2
Deketelaere Benjamin	UCLouvain Wolves	B6	3
Brico Nathan	EPHEC	B6	1

Joueur 1	Joueur 2	Arbitre	Score	
Di Pietro Noah	Brico Nathan	Deketelaere Benjamin	0	3
Deketelaere Benjamin	Brico Nathan	Di Pietro Noah	1	3
Di Pietro Noah	Deketelaere Benjamin	Brico Nathan	3	1

Poule 2 Homme A+B			
Noms	Club	CL	Pos
Stanescu Gabriel	UCLouvain Wolves	B0	1
Carpentier Colin	UCLouvain Wolves	B6	3
Guo Xin	Universiteit Gent	B6	2

Joueur 1	Joueur 2	Arbitre	Score	
Stanescu Gabriel	Guo Xin	Carpentier Colin	3	1
Carpentier Colin	Guo Xin	Stanescu Gabriel	1	3
Stanescu Gabriel	Carpentier Colin	Guo Xin	3	0

Poule 3 Homme A+B			
Noms	Club	CL	Pos
Vanvinckenroye Matthias	Hogeschool pxl	B2	1
Fikany Jean Pierre	UCLouvain Wolves	B6	3
Ketele Amaury	UCLouvain Wolves	B6	2

Joueur 1	Joueur 2	Arbitre	Score	
Vanvinckenroye Matthias	Ketele Amaury	Fikany Jean Pierre	3	2
Fikany Jean Pierre	Ketele Amaury	Vanvinckenroye Matthias	2	3
Vanvinckenroye Matthias	Fikany Jean Pierre	Ketele Amaury	3	1

Poule 4 Homme A+B			
Noms	Club	CL	Pos
Devue Wouter	Odisee hogeschool	B2	2
Maquestiau Martin	Uliège	B4	1
Foguenne Emile	UCLouvain Wolves	B6	3

Joueur 1	Joueur 2	Arbitre	Score	
Devue Wouter	Foguenne Emile	Maquestiau Martin	3	0
Maquestiau Martin	Foguenne Emile	Devue Wouter	3	2
Devue Wouter	Maquestiau Martin	Foguenne Emile	2	3

# Tournoi inter universitaire Série: Homme A+B

1/4

1/2

Finale

1	Brico Nathan EPHEC	B6	0
8	Devue Wouter Odisee hogeschool	B2	3
5	Di Pietro Noah UCLouvain Wolves	B0	3
4	Maquestiau Martin Uliège	B4	2
3	anvinckenroye Matthias Hogeschool p	B2	1
6	Guo Xin Universiteit Gent	B6	3
7	Ketele Amaury UCLouvain Wolves	B6	1
2	Stanescu Gabriel UCLouvain Wolves	B0	3

Devue Wouter Odisee hogeschool

0
3

Di Pietro Noah UCLouvain Wolves

Di Pietro Noah UCLouvain Wolves

Guo Xin Universiteit Gent

0
3

Stanescu Gabriel UCLouvain Wolves

Stanescu Gabriel UCLouvain Wolves

2

1 Stanescu Gabriel UCLouvain Wolves B0

3

2 Di Pietro Noah UCLouvain Wolves B0

3 Devue Wouter Odisee hogeschool B2

4 Guo Xin Universiteit Gent B6

Petite finale

Devue Wouter Odisee hogeschool	3
Guo Xin Universiteit Gent	1

Poule 1 Homme C+D			
Noms	Club	CL	Pos
Barbarin Noa	HELHa	C0	1
Zhu Juncheng	KU Leuven	D0	3
Stove Steven	HEH	D2	2

Joueur 1	Joueur 2	Arbitre	Score	
Barbarin Noa	Stove Steven	Zhu Juncheng	3	0
Zhu Juncheng	Stove Steven	Barbarin Noa	1	3
Barbarin Noa	Zhu Juncheng	Stove Steven	3	0

Poule 2 Homme C+D			
Noms	Club	CL	Pos
Hanssens Cedric	ULB Owls	C0	3
Ooghe Jasper	Hogeschool Gent	D0	2
Debroux Bastien	UCLouvain Wolves	D2	1

Joueur 1	Joueur 2	Arbitre	Score	
Hanssens Cedric	Debroux Bastien	Ooghe Jasper	0	3
Ooghe Jasper	Debroux Bastien	Hanssens Cedric	1	3
Hanssens Cedric	Ooghe Jasper	Debroux Bastien	0	3

Poule 3 Homme C+D			
Noms	Club	CL	Pos
KWAN Oswin	ULiège	C0	1
Ghyoot Yoshi	Universiteit Gent	C6	2
Haincourt Julien	UMONS Dragons	D2	3

Joueur 1	Joueur 2	Arbitre	Score	
KWAN Oswin	Haincourt Julien	Ghyoot Yoshi	3	0
Ghyoot Yoshi	Haincourt Julien	KWAN Oswin	3	1
KWAN Oswin	Ghyoot Yoshi	Haincourt Julien	3	1

Poule 4 Homme C+D			
Noms	Club	CL	Pos
Alexandre-Martin Samuel	UCLouvain Wolves	C2	1
Swaenepoel Gust	Hogeschool VIVES Noord	C6	2
Barremaecker Ruben	Universiteit Gent	D2	3

Joueur 1	Joueur 2	Arbitre	Score	
Alexandre-Martin Samuel	Barremaecker Ruben	Swaenepoel Gust	3	1
Swaenepoel Gust	Barremaecker Ruben	Alexandre-Martin Samuel	3	1
Alexandre-Martin Samuel	Swaenepoel Gust	Barremaecker Ruben	3	1

Poule 5 Homme C+D			
Noms	Club	CL	Pos
Mailleux Igor	HELMo	C2	2
Alloin Clément	ULB Owls	C4	1
Weingärtner Paul	UCLouvain Wolves	D4	3

Joueur 1	Joueur 2	Arbitre	Score	
Mailleux Igor	Weingärtner Paul	Alloin Clément	3	1
Alloin Clément	Weingärtner Paul	Mailleux Igor	3	0
Mailleux Igor	Alloin Clément	Weingärtner Paul	0	3

Poule 6 Homme C+D			
Noms	Club	CL	Pos
Vandepitte Pierre	Uliège (gembloux)	C2	2
Lindhard Toke	UCLouvain Wolves	C4	3
Delahaye Dan	ULB Owls	D4	1

Joueur 1	Joueur 2	Arbitre	Score	
Vandepitte Pierre	Delahaye Dan	Lindhard Toke	0	3
Lindhard Toke	Delahaye Dan	Vandepitte Pierre	1	3
Vandepitte Pierre	Lindhard Toke	Delahaye Dan	3	0



Poule 7 Homme C+D			
Noms	Club	CL	Pos
Li Zongyuan	KU Leuven	C2	3
Vancauwenberghe Jeyson	HEH	C4	2
Fosseur Nicolas	ULB Owls	D4	1

Joueur 1	Joueur 2	Arbitre	Score	
Li Zongyuan	Fosseur Nicolas	Vancauwenberghe Jeyson	2	3
Vancauwenberghe Jeyson	Fosseur Nicolas	Li Zongyuan	0	3
Li Zongyuan	Vancauwenberghe Jeyson	Fosseur Nicolas	1	3

Poule 8 Homme C+D			
Noms	Club	CL	Pos
Rui Zhu	KU Leuven	C2	2
Devue Dieter	Universiteit Hasselt	C2	1
Petit Joachim	ULB Owls	D6	3

Joueur 1	Joueur 2	Arbitre	Score	
Rui Zhu	Petit Joachim	Devue Dieter	3	1
Devue Dieter	Petit Joachim	Rui Zhu	3	2
Rui Zhu	Devue Dieter	Petit Joachim	1	3

## Tournoi inter universitaire Série: Homme C+D

1/8

1/4

1/2

Finale

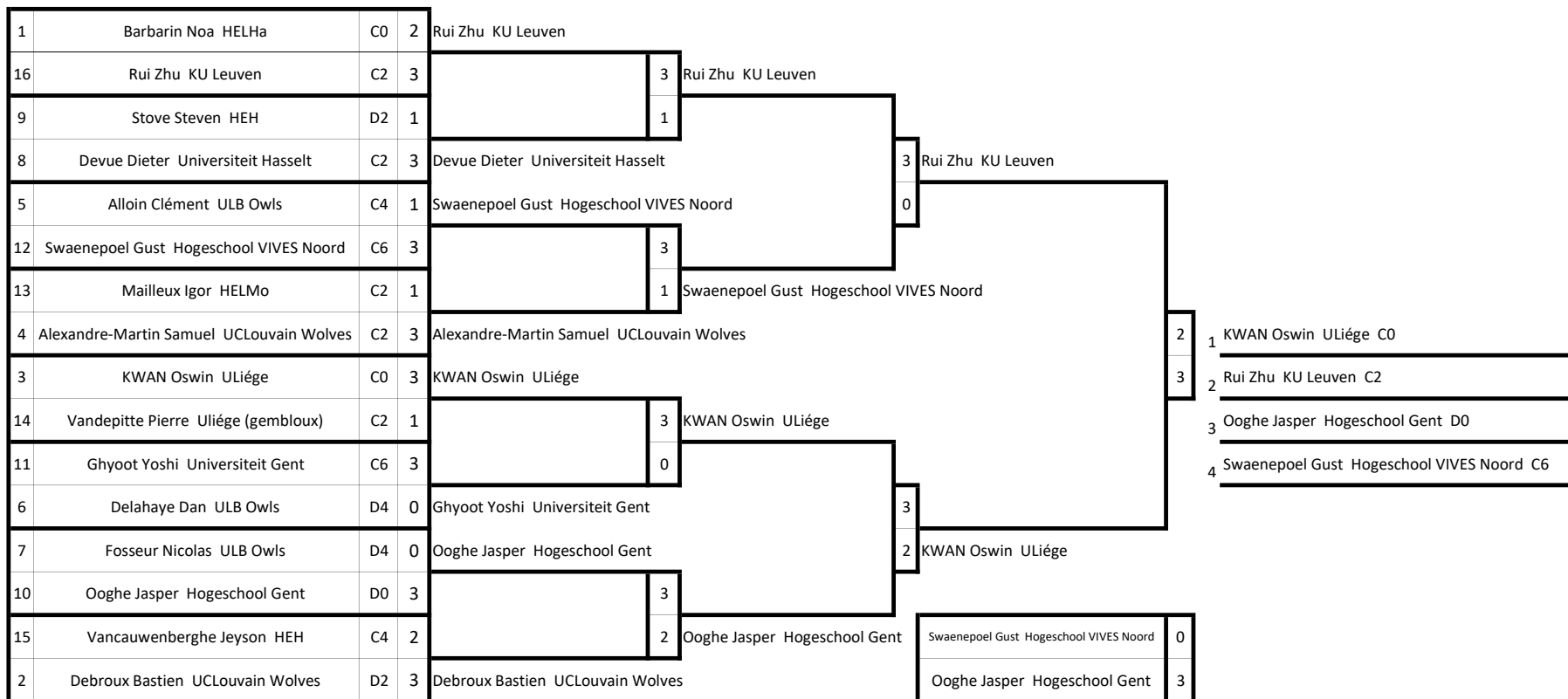

Poule 1 Homme E+NC			
Noms	Club	CL	Pos
Hsia Peng	UMONS Dragons	E0	1
Kalonji Antoine	HELHa	NC	3
Laurent Josselyn	HELHa	NC	2

Joueur 1	Joueur 2	Arbitre	Score	
Hsia Peng	Laurent Josselyn	Kalonji Antoine	3	0
Kalonji Antoine	Laurent Josselyn	Hsia Peng	0	3
Hsia Peng	Kalonji Antoine	Laurent Josselyn	3	0

Poule 2 Homme E+NC			
Noms	Club	CL	Pos
Sibille Matteo	HEH	E2	1
Benbouali Sofiane	HEPH	NC	2
PLESEL Younes	HELHa	NC	3

Joueur 1	Joueur 2	Arbitre	Score	
Sibille Matteo	PLESEL Younes	Benbouali Sofiane	3	0
Benbouali Sofiane	PLESEL Younes	Sibille Matteo	3	0
Sibille Matteo	Benbouali Sofiane	PLESEL Younes	3	1

Poule 3 Homme E+NC			
Noms	Club	CL	Pos
Baidouri Balir	UMONS Dragons	E2	2
Vienne Jason	HEPH	E6	1
Sprimont Jérémy	HELHa	NC	3

Joueur 1	Joueur 2	Arbitre	Score	
Baidouri Balir	Sprimont Jérémy	Vienne Jason	3	0
Vienne Jason	Sprimont Jérémy	Baidouri Balir	3	0
Baidouri Balir	Vienne Jason	Sprimont Jérémy	0	3

Poule 4 Homme E+NC			
Noms	Club	CL	Pos
Honoré Mael	UMONS Dragons	E2	1
Ceysens Nicolas	UMONS Dragons	E4	2
Girard Anaël	HELHa	NC	3

Joueur 1	Joueur 2	Arbitre	Score	
Honoré Mael	Girard Anaël	Ceysens Nicolas	3	0
Ceysens Nicolas	Girard Anaël	Honoré Mael	3	0
Honoré Mael	Ceysens Nicolas	Girard Anaël	3	2

Poule 5 Homme E+NC			
Noms	Club	CL	Pos
Baudrez Mathias	HELHa	E4	2
Hanssens Tom	UCLouvain Wolves	E4	1
Pourignaux Evan	UMONS Dragons	NC	3

Joueur 1	Joueur 2	Arbitre	Score	
Baudrez Mathias	Pourignaux Evan	Hanssens Tom	3	1
Hanssens Tom	Pourignaux Evan	Baudrez Mathias	3	0
Baudrez Mathias	Hanssens Tom	Pourignaux Evan	0	3

# Tournoi inter universitaire Série: Homme E+NC

1/8

1/4

1/2

Finale

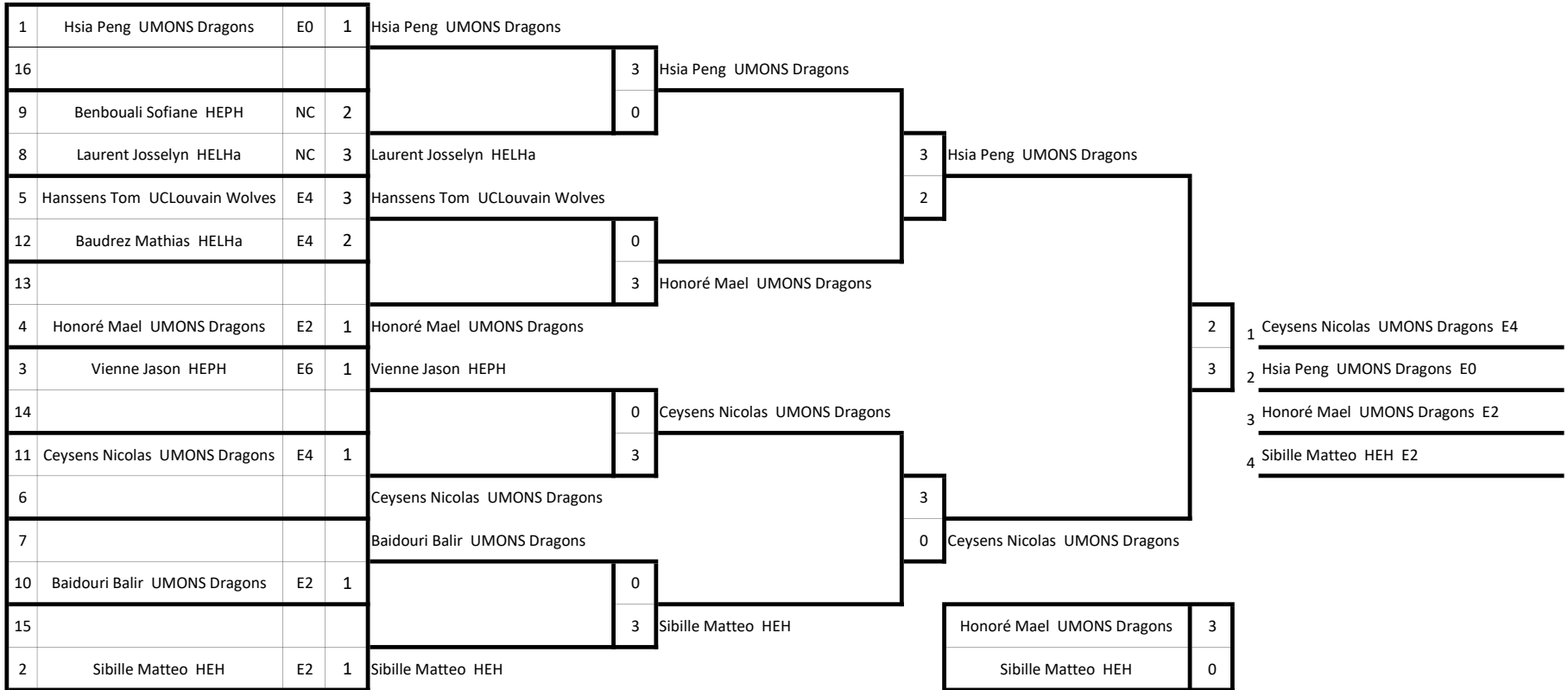

# Résultats du Championnat FSUB de Triathlon

Seneffe

Dimanche 26 mai 2024



# Résultats dames

Triathlon de Seneffe 2024

## Classement général Distance Olympique

Pl.	Doss	Nom Prénom	Sx	Pl.S	Club	Licence	Nat.	T1	Vélo	T2	Course	Arrivée	
Distance Olympique													
49.	213	DE HERDE, Laura	F	1	TribuPerformance	131469F98		24:16	03:02	1:09:12	04:30	40:28	2:21:28
54.	141	LOUPPE, Stéphanie	F	2	PMX	57352F79		24:42	02:54	1:10:17	02:33	42:45	2:23:11
70.	84	MOMMEN, Inès	F	3	BTC	59743F99		23:41	03:03	1:13:20	02:35	43:43	2:26:22
74.	17	DUQUENNOY, Kimberlay	F	4	3nergy coaching	65596F99		27:33	03:22	1:09:39	02:37	44:10	2:27:21
82.	306	DECAESTEKER-BAELEN, Marion	F	5		133219F02		24:58	03:20	1:12:14	02:38	45:01	2:28:11
85.	16	DE WILDE, Lotte	F	6	3Kant	109322F01		24:15	03:28	1:15:28	03:01	42:35	2:28:47
103.	161	DE TERWANGNE, Nikita	F	7	RCBT	65296F98		24:23	02:53	1:15:37	02:39	46:20	2:31:52
110.	209	GOOSSENS, Sarah	F	8	Triatlon Vlaanderen	45280F93		24:20	03:47	1:15:39	03:20	46:10	2:33:16
117.	75	ENGELS, Marie	F	9	BTC	64895F90		21:55	03:17	1:15:58	03:06	50:02	2:34:18
118.	234	CREMER, Solange	F	10	TTDA	65478F97		21:52	04:05	1:16:27	03:06	49:13	2:34:43
121.	216	THEATE, Francoise	F	11	TRIGT	58002F63		22:43	03:24	1:19:39	03:03	46:08	2:34:57
122.	10	PANAGIOTIDIS, Marine	F	12	TTB	62985F04		22:49	03:05	1:16:31	03:24	49:11	2:35:00
124.	83	CLINQUART, Charlotte	F	13	BTC	66102F99		24:20	04:12	1:16:35	02:38	47:47	2:35:32
133.	129	BRASSEUR, Marie	F	14	nstt	62841F79		28:45	03:42	1:13:16	03:02	47:50	2:36:35
135.	240	DELESTINNE, Olivia	F	15	UCL wolves	/		26:59	03:03	1:18:07	02:38	46:06	2:36:53
139.	186	VAN ESPEN, Inès	F	16	TCDM	65546F04		24:39	03:09	1:19:19	02:35	47:43	2:37:25
143.	6	GODTS, Gwenaëlle	F	17	NSTT	63608F99		25:01	03:04	1:21:08	03:07	47:01	2:39:21
145.	41	RUBAN, Sophie	F	18	ATCC	61002F88		29:08	05:15	1:17:16	03:02	45:09	2:39:50
152.	64	PATRY, Anne	F	19	Besançon Triathlon	A63610C		22:54	03:01	1:23:16	03:23	48:39	2:41:13
154.	255	GRAINGER CLEMSON, Hannah	F	20		115879F77		30:08	03:30	1:18:15	03:01	46:36	2:41:30
158.	80	VANCOPPENOLLE, Zoé	F	21	BTC	66031F96		28:06	02:51	1:20:27	03:09	48:01	2:42:34
161.	66	VERVENNE, Margaux	F	22	BMT	118099F00		30:49	03:56	1:18:32	03:47	45:49	2:42:53
163.	24	TERWAGNE, Aurore	F	23	3T	65433F84		28:17	03:51	1:18:25	03:12	50:00	2:43:45
164.	153	EGGER, Clara	F	24	RCBT	65251F88		32:10	03:15	1:21:14	03:05	44:27	2:44:11
166.	42	WEYNAND, Marjolaine	F	25	ATCC	64199F91		33:16	04:34	1:15:04	04:46	46:57	2:44:37
168.	45	PARENT, Elise	F	26	AUCUN	66708F02		27:47	03:20	1:20:32	03:08	50:51	2:45:38
189.	145	KULESZA - WALCZAK, Wioletta	F	27	RCBT	62522F76		27:28	03:41	1:20:05	03:41	56:25	2:51:20
194.	273	KORPAR, Miriam	F	28				26:34	03:19	1:27:58	03:28	52:00	2:53:19
201.	214	DUVIVIER, Noémie	F	29	Tricalidi	66171M00		33:24	04:15	1:20:03	03:43	53:18	2:54:43



# Triathlon de Seneffe 2024

## Classement général Distance Olympique

Pl.	Doss	Nom Prénom	Sx	Pl.S	Club	Licence	Nat.	T1	Vélo	T2	Course	Arrivée
203.	293	REALES, Sandra	F	30		66554F95	26:21	05:23	1:23:55	03:34	56:29	2:55:42
209.	236	MOTTARD, Sophie	F	31	TTF	64948F78	27:47	05:01	1:27:33	04:32	51:43	2:56:36
210.	297	GILLARD, Deborah	F	32			32:21	04:06	1:22:11	03:46	54:27	2:56:51
212.	221	FLAS, Mathilde <i>Ulg (G)</i>	F	33	TRILGE	/	25:21	03:53	1:26:10	03:38	58:50	2:57:52
214.	233	CREMER, Céline	F	34	TTDA	64616F94	28:54	04:56	1:20:43	04:31	59:03	2:58:07
215.	51	BLOTHIAUX, Aline <i>UCL W</i>	F	35	Aucun	/	23:45	04:03	1:34:28	02:54	53:35	2:58:45
221.	231	MATHELET, Lise	F	36	TTB	63783F95	27:56	05:03	1:24:52	04:28	58:01	3:00:20
223.	31	TRIQUET, Sarah	F	37	3T	65023F95	34:46	04:21	1:22:03	04:09	55:50	3:01:09
226.	279	HALILI, Mimoza	F	38			33:54	04:48	1:26:29	04:02	52:06	3:01:19
228.	138	MINNAERT, Carole	F	39	PDOTeam	62771f84	32:17	04:40	1:28:49	03:56	52:17	3:01:59
231.	162	LAPORTE, Eline	F	40	RCBT		28:16	04:47	1:25:24	03:50	1:00:37	3:02:54
234.	56	MINEO, Louise <i>UCL W</i>	F	41	AUCUN	/	33:30	04:47	1:25:57	04:18	55:45	3:04:17
235.	60	MATHIEU, Margaux <i>KUleuven</i>	F	42	AUCUN	/	29:19	05:17	1:34:00	02:54	54:12	3:05:42
236.	155	MINJAUW, Colette	F	43	RCBT		34:44	04:20	1:28:21	04:37	56:23	3:08:25
239.	88	MAADINI, Julia	F	44	Cariboost	66515F96	30:28	04:41	1:25:53		3:08:34	3:08:34
242.	122	KAPUCZINSKI, Abeline	F	45	Madres	66574F93	37:02	05:00	1:36:40	03:06	47:53	3:09:41
246.	55	AGIE, Liane <i>UCL W</i>	F	46	AUCUN	/	32:22	05:21	1:32:11	02:55	57:53	3:10:42
249.	201	MULLER, Helena	F	47	Tri M2R	80653f88	34:29	04:45	1:22:54	04:39	1:06:00	3:12:47
251.	36	VANESSE, Myriam	F	48	ATCC	58257f64	32:23	05:21	1:31:02	04:32	1:01:08	3:14:26
253.	106	KETELE, Coralie	F	49	Gag / Fleu		34:22	05:20	1:37:52	03:42	55:37	3:16:53
254.	247	MAWET, Nathalie	F	50			37:22	05:06	1:29:53	04:35	1:00:43	3:17:39
255.	271	DUBOIS, Héloïse**	F	51			33:48	05:18	1:31:10	04:57	1:02:26	3:17:39
259.	258	JANSEN, Caroline**	F	52			36:50	05:13	1:35:11	04:32	1:02:39	3:24:25
261.	226	LECHARLIER, Katana	F	53	TTB	61251F67	34:23	06:05			3:25:25	3:25:25
265.	281	DE CONINCK, Jessica	F	54			30:14	05:19	1:50:14	06:47	59:55	3:32:29
267.	245	SIDLER, Sophie	F	55			36:28	07:35	1:44:15	06:07	1:06:56	3:41:21
268.	280	MEEUS, Manon	F	56			36:12	06:11	1:51:36	06:38	1:02:05	3:42:42
269.	248	FALLON, Valerie	F	57			37:46	06:09	1:50:46	06:14	1:04:44	3:45:39
270.	69	TACHEAU, Marie	F	58	Brussels triathlon club	66104F01	39:36	05:49	1:38:13	06:46	1:20:16	3:50:40
DNF	163	MOREAU, Marie <i>VUB</i>	F	-1	RCBT	59421F00	28:11	03:04				
DNF	239	SIMONET, Victoria <i>UCL W</i>	F	-1	TURBO	59639D04	24:15	03:34	1:22:20	03:05	37:05	2:30:19



# Résultats Hommes

Triathlon de Seneffe 2024

## Classement général Distance Olympique

Pl.	Doss	Nom Prénom	Sx	Pl.S	Club	Licence	Nat.	T1	Vélo	T2	Course	Arrivée
1.	169	LAMBRECHT, Arno	M	1	Sportics-Tri-Team	30016M94	19:58	02:42	1:03:31	02:15	34:01	2:02:27
2.	117	ROSU, Michael	M	2	LSTT	57780M81	19:45	02:25	1:02:13	02:12	36:03	2:02:38
3.	7	DEWEZ, Maxime HELT6	M	3	PMX	62733M02	20:25	02:16	1:03:22	02:03	35:23	2:03:29
4.	218	ROLIN, Boris	M	4	Trigt	56244H87	22:35	02:44	1:00:57	02:13	35:27	2:03:56
5.	208	DENOLF, Ward ER7	M	5	Triatlon Brugge Team	21977M02	19:45	02:38	1:03:18	02:13	37:01	2:04:55
6.	160	BLANCHARD, Victor	M	6	RCBT	64534M96	21:05	02:59	1:02:55	02:06	35:59	2:05:04
7.	3	PLATIAUX, Robin HEPHC	M	7	Endurance Team Chièvres	65121M03	22:50	04:22	1:02:19	02:37	35:20	2:07:28
8.	191	GRIFGNEE, Maxime	M	8	TDCH	62723M95	21:11	02:36	1:03:49	02:25	37:40	2:07:41
9.	4	GOUDEMANT, Tom UCL W	M	9	GTC	60418M02	21:40	02:37	1:04:06	02:42	36:56	2:08:01
10.	154	HEYRMAN, Jonathan	M	10	rcbt	61391M91	21:41	02:23	1:04:36	02:24	36:59	2:08:03
11.	140	CLEMENT, François**	M	11	PMX	56455M77	21:42	02:43	1:03:43	02:24	37:37	2:08:09
12.	43	VAN WAETERMEULEN, Yanis	M	12	ATCC	64131m05	21:40	02:23	1:07:37	02:26	34:23	2:08:29
13.	77	SOMERS, Ludovic	M	13	BTC	57713M92	21:23	02:39	1:02:15	02:17	40:07	2:08:41
14.	168	VAN BELLE, Glenn	M	14	SP&O	48344M93	24:05	03:46	1:03:37	02:18	35:32	2:09:18
15.	8	VANBELLAIENGH, Julien	M	15	TCDM	63487M94	21:10	02:06	1:06:10	02:43	37:18	2:09:27
16.	81	GUEUNING, Louis	M	16	BTC	65544M97	21:34	02:36	1:05:14	02:24	38:00	2:09:48
17.	61	LECLER, Quentin HERS	M	17	BATT	65940M03	23:53	02:32	1:06:10	02:07	35:31	2:10:13
18.	152	PETTEAU, Adrien	M	18	RCBT	58653M87	21:46	02:34	1:04:53	02:23	38:54	2:10:30
19.	12	ZABALA, Fernando	M	19	/	126883M90	22:36	03:37	1:03:32	02:46	38:18	2:10:49
20.	27	ROLDAN-SIMON, Adrien	M	20	3T	61739m90	21:32	02:42	1:05:54	02:42	38:26	2:11:16
21.	1	GILBERT, Emilien	M	21	TCA	64768M00	22:11	02:45	1:08:19	02:07	37:17	2:12:39
22.	65	CARRERA, Xabier	M	22	BIN	20948M78	24:45	03:19	1:03:23	02:29	38:55	2:12:51
23.	173	LEFEBVRE, Léopold	M	23	TCA		23:59	02:43	1:05:39	02:34	38:18	2:13:13
24.	185	VAN DUYSE, Lucas UCL W	M	24	TCDM	65830M05	22:30	02:50	1:07:21	02:23	38:19	2:13:23
25.	167	VAN BELLE, Joeri	M	25	SP&O	32975M90	21:51	02:41	1:07:38	02:35	39:23	2:14:08
26.	195	VANDENBRANDE, Steven	M	26	TDL	22727M88	27:13	02:58	1:03:40	02:42	37:55	2:14:28
27.	211	WILLEMART, Samuel UCL W	M	27	Tri-B	64042m05	21:28	02:29	1:07:35	02:45	40:41	2:14:58
28.	210	EMBRECHTS, Lucas	M	28	TRI-B	64549M98	24:37	02:35	1:09:20	02:22	36:05	2:14:59
29.	86	KYRIAKIDES, Niels UA	M	29	BTC	66233M04	21:00	03:00	1:06:14	02:54	42:04	2:15:12
30.	136	MAILOT, Adrien	M	30	P8	60750M03	22:16	02:32	1:08:12	02:29	40:17	2:15:46
31.	26	BRUN, Logan	M	31	3T	62899M90	23:28	02:46	1:06:44	02:40	41:06	2:16:44

# Triathlon de Seneffe 2024

## Classement général Distance Olympique

Pl.	Doss	Nom Prénom	Sx	Pl.S	Club	Licence	Nat.	T1	Vélo	T2	Course	Arrivée	
32.	101	GRIMONPREZ, Julien	M	32	ETM	60403M87		23:38	03:34	1:07:17	03:13	39:03	2:16:45
33.	47	LECROART, Théo <i>HEH</i>	M	33	AUCUN	/		21:25	03:52	1:04:02	02:52	45:02	2:17:13
34.	73	ROBBERECHTS, Tom	M	34	BTC	61937M75		25:05	02:41	1:05:43	02:22	41:40	2:17:31
35.	157	GHOMRAOUI, Bilal	M	35	RCBT	59161M93		23:30	02:37	1:04:43	05:06	41:52	2:17:48
36.	9	LOUIS, Arthur <i>Ulg (lg)</i>	M	36	TRILGE	65404M00		21:42	02:37	1:08:20	02:48	42:47	2:18:14
37.	192	MARENNE, Simon	M	37	TDCH	65768M04		26:35	04:06	1:06:00	03:22	38:18	2:18:21
38.	215	VERMEIRE, Martin <i>HELG</i>	M	38	TriGS	63909M03		23:33	03:06	1:07:25	02:30	41:57	2:18:31
39.	204	MAES, Jochen	M	39	Triathlon club Andenne	65373M88		27:20	03:12	1:05:48	03:24	38:48	2:18:32
40.	18	SFERRAZZA, Martin	M	40	3nergy coaching	65528M99		27:14	03:10	1:06:03	02:54	39:40	2:19:01
41.	111	MOONEN, Gert	M	41	Iron Team Medhelen	00570M72		24:56	03:23	1:08:18	02:46	39:51	2:19:14
42.	53	DECOENE, Simon <i>UCL W</i>	M	42	Aucun	/		24:39	02:49	1:05:45	03:01	43:18	2:19:32
43.	244	VAN DER STIGHELEN, Joran <i>KULeuven</i>	M	43	WTT	40663M05		24:03	02:46	1:09:00		2:19:39	2:19:39
44.	82	DE WILDE, Régis	M	44	BTC	63746M98		24:43	02:38	1:13:01	02:07	37:22	2:19:51
45.	198	SERRUYS, Sébastien	M	45	Titan	66819H97		26:21	04:37	1:08:51	03:05	37:19	2:20:13
46.	124	SCHETSKE, Jurgen	M	46	MTT	32623M80		26:25	03:48	1:05:41	02:44	41:42	2:20:20
47.	87	WILLOCX, Jérôme	M	47	Cariboost	59144M96		27:28	04:38	1:03:25	03:16	41:49	2:20:36
48.	126	CALLEWAERT, Simon	M	48	Nit	01905M92		23:21	02:54	1:12:24	02:29	40:18	2:21:26
50.	68	STERPIN, Edmond	M	49	Brussels Triathlon Club	56190M80		24:16	03:07	1:12:23	02:43	39:24	2:21:53
51.	207	GOEMINNE, Kevin	M	50	Triathlon vlaanderen	11443M85		24:58	03:36	1:09:10	02:52	41:19	2:21:55
52.	277	ANDRE, Maxime***	M	51				25:11	03:49	1:07:44	03:42	41:38	2:22:04
53.	202	GEORGES, Florian	M	52	Triathliège	65841M00		26:34	03:13	1:10:39	03:04	39:41	2:23:11
55.	72	ROMAGUERA BOSCH, Jordi	M	53	BTC	60130M68		25:05	02:37	1:11:39	02:29	41:36	2:23:26
56.	194	BLOMME, Raf	M	54	TDL	02912M82		24:50	03:22	1:08:21	03:14	43:59	2:23:46
57.	137	PARTHOENS, Florian	M	55	P8	65637M04		26:36	03:49	1:11:35	02:42	39:06	2:23:48
58.	197	BROICH, Markus	M	56	Team Erdinger	00-8000100154791974		25:25	02:43	1:11:14	03:20	41:12	2:23:54
59.	205	QUADFLIEG, Jordan	M	57	Triathlon Team Fagnes	64832M93		27:01	03:51	1:09:36	03:24	40:19	2:24:11
60.	166	COUSAERT, Kenny	M	58	Schelde Effort Team	25413M80		25:34	03:32	1:10:44	02:29	42:05	2:24:24
61.	94	BOIGELOT, Simon	M	59	Detralytics			26:29	03:17	1:11:42	03:38	39:19	2:24:25
62.	241	VICKEVORST, Geoffrey	M	60	VitaliTri	59950M86		24:23	02:52	1:10:55	03:13	43:13	2:24:36
63.	199	GOSSIAUX, Remi	M	61	TNT	65921M01		29:48	03:57	1:09:48	02:22	38:42	2:24:37
64.	203	KANKELJ, Arnaud	M	62	Triathliège	65673M89		29:35	04:07	1:09:42	02:34	38:52	2:24:50



# Triathlon de Seneffe 2024

## Classement général Distance Olympique

Pl.	Doss	Nom Prénom	Sx	Pl.S	Club	Licence	Nat.	T1	Vélo	T2	Course	Arrivée
65.	74	ALBERT, Robin*	M	63	BTC	63474M90	27:41	03:07	1:07:53	02:46	43:26	<b>2:24:53</b>
66.	219	KESTELYN, Baptiste	M	64	TRIGT	56930M89	26:50	04:21	1:06:54	02:48	44:20	<b>2:25:13</b>
67.	102	VERCRUYSSSE, Thibaut	M	65	ETM	60432M88	25:50	03:39	1:10:51	02:48	42:20	<b>2:25:28</b>
68.	79	VAN CAILLIE, François	M	66	BTC	64484M94	21:45	03:02	1:13:34	03:33	44:13	<b>2:26:07</b>
69.	96	BOSSUT, Martin	M	67	Endurance Team Chièvres	66485M00	27:17	04:42	1:12:54	02:49	38:32	<b>2:26:14</b>
71.	19	ASSELMAN, Niels	M	68	3PT	105254M91	28:40	04:57	1:07:10	03:31	42:06	<b>2:26:24</b>
72.	59	KAJUS, Marozas <i>KUlewen</i>	M	69	AUCUN	/	22:17	03:44	1:13:03	03:26	44:24	<b>2:26:54</b>
73.	46	BIERNAUX, Doriano <i>HE2B</i>	M	70	AUCUN	/	26:14	03:08	1:11:05	02:42	43:48	<b>2:26:57</b>
75.	238	DEVULDER, Arnaud	M	71	TURBO	58271M85	23:53	03:43	1:12:29	03:00	44:25	<b>2:27:30</b>
76.	237	CAZAL, Hadrien	M	72	TURBO		23:55	04:06	1:11:14	03:43	44:32	<b>2:27:30</b>
77.	62	LIEGEOIS, Noah	M	73	BATT	65305M05	29:00	03:37	1:12:50	02:44	39:21	<b>2:27:32</b>
78.	76	DESMARETS, Thibaut	M	74	BTC	62332M91	25:36	03:41	1:12:36	03:36	42:03	<b>2:27:32</b>
79.	105	CONNOTTE, Fabian	M	75	Eupen	62813M93	31:22	04:51	1:06:54	02:49	41:49	<b>2:27:45</b>
80.	23	DOHN, Christophe	M	76	3T	65024M70	29:17	04:20	1:10:46	03:35	39:50	<b>2:27:48</b>
81.	178	LOGNARD, Edwin	M	77	TCBM	62413M77	27:24	04:18	1:09:43	03:20	43:19	<b>2:28:04</b>
83.	165	ELEN, Niels	M	78	SCBTRI	66643M04	28:26	03:02	1:09:18	02:59	44:28	<b>2:28:13</b>
84.	158	VAN MELKEBEKE, Andres	M	79	RCBT	66293M95	29:12	03:21	1:09:37	03:49	42:23	<b>2:28:22</b>
86.	103	SIMOENS, Remi	M	80	ETM	65787M01	30:48	03:24	1:14:01	02:53	37:42	<b>2:28:48</b>
87.	116	PAUWELS, Christophe*	M	81	LG	61492M83	27:23	03:59	1:11:42	02:48	43:01	<b>2:28:53</b>
88.	252	CORREIA DA SILVA, Paulo Jorge	M	82			28:03	03:15	1:12:44	02:54	42:19	<b>2:29:15</b>
89.	307	TOUSSAINT, Timothée	M	83			25:38	03:44	1:14:29	03:08	42:27	<b>2:29:26</b>
90.	13	WIERTZ, Nathan	M	84	/		30:47	03:26	1:09:44	03:30	42:30	<b>2:29:57</b>
91.	254	ALBI, Stephane	M	85			27:37	03:44	1:12:04	03:36	43:01	<b>2:30:02</b>
92.	182	GUTIERREZ, Marcos	M	86	TCDM		29:42	04:21	1:11:23	03:01	41:37	<b>2:30:04</b>
93.	104	HENZ, Olivier	M	87	EUPEN	60506M71	29:18	03:17	1:09:53		2:30:37	<b>2:30:37</b>
94.	44	EVARD, Jean-Francois***	M	88	ATTC	64911M74	28:48	04:03	1:12:06	03:10	42:40	<b>2:30:47</b>
95.	235	BOLDO, David	M	89	TTF	63224M75	28:28	03:30	1:09:13	03:00	46:40	<b>2:30:51</b>
96.	22	PIRARD, Vincent**	M	90	3T	65256M79	24:59	03:30	1:14:12	03:13	45:29	<b>2:31:23</b>
97.	246	DELHAYE, Luc	M	91		60453M66	25:15	04:04	1:13:20	03:11	45:33	<b>2:31:23</b>
98.	33	LHOST, Florent	M	92	3T	63798M05	23:53	03:03	1:12:46	03:47	48:11	<b>2:31:40</b>
99.	25	DRUINE, Pierre	M	93	3T	65432M88	27:13	04:13	1:08:56	03:10	48:11	<b>2:31:43</b>

# Triathlon de Seneffe 2024

## Classement général Distance Olympique

Pl.	Doss	Nom Prénom	Sx	Pl.S	Club	Licence	Nat.	T1	Vélo	T2	Course	Arrivée
100.	285	VAN DYCK, Mattias	M	94			28:08	04:21	1:13:36	03:15	42:27	<b>2:31:47</b>
101.	272	WATELET, Corentin	M	95			31:51	03:56	1:09:31	03:17	43:13	<b>2:31:48</b>
102.	289	BECKERS, Médéric	M	96			28:54	06:15	1:09:40	03:51	43:09	<b>2:31:49</b>
104.	292	CREPIN, Rémi	M	97			21:41	04:08	1:11:06	03:23	52:01	<b>2:32:19</b>
105.	128	VERGEZ, Xavier	M	98	Nstt	64236M75	29:40	03:31	1:14:21	02:52	42:02	<b>2:32:26</b>
106.	91	BLONDEL, Jean-Baptiste	M	99	Chalet de la forêt Trail team		26:18	04:05	1:16:07	03:45	42:11	<b>2:32:26</b>
107.	90	LEGAT, Guillaume	M	100	CCT	62120m88	26:49	03:52	1:11:42	03:03	47:14	<b>2:32:40</b>
108.	135	GILLET, Clement	M	101	P8	66556M00	29:45	04:03	1:11:47	03:38	43:44	<b>2:32:57</b>
109.	78	SCHAEFFER, Paul-Etienne	M	102	BTC	63198M92	27:15	04:10	1:13:40	03:59	43:57	<b>2:33:01</b>
111.	5	DEWEZ, Bastien	M	103	NSTT	65766M87	24:32	03:55	1:12:41	03:42	48:31	<b>2:33:21</b>
112.	130	MASSART, Adelin	M	104	NSTT	66706M98	26:49	04:10	1:12:53	02:53	46:54	<b>2:33:39</b>
113.	144	REMY, Sebastien**	M	105	RCBT	59406M72	25:08	03:35	1:15:11	02:52	46:59	<b>2:33:45</b>
114.	212	STAQUET, Arnaud	M	106	Tribikestation	63153M82			1:29:50		2:33:50	<b>2:33:50</b>
115.	296	DEBRAY, Charles-Emmanuel	M	107		66799M94	28:46	04:38	1:11:08	03:11	46:26	<b>2:34:09</b>
116.	109	LEFEBVRE, Maël <i>UCL W</i>	M	108	GTC	/	28:14	03:28	1:19:22	02:33	40:37	<b>2:34:14</b>
119.	278	MANTA, Lionel	M	109			28:38	04:32	1:11:52	03:52	45:50	<b>2:34:44</b>
120.	256	CHATELUS, Sebastien	M	110		A10851C0160000MV2FR	27:41	03:57	1:13:50	03:36	45:43	<b>2:34:47</b>
123.	181	BARTHOLOME, Juan	M	111	TCBM	60039M92			1:44:50		2:35:10	<b>2:35:10</b>
125.	71	GOSSELE, Filip	M	112	BTC	60842m65	31:03	03:25	1:11:04	03:00	47:15	<b>2:35:47</b>
126.	243	DE COSTER, Cedric	M	113	Waterloo Triathlon	56142M79	27:50	04:01	1:10:50		2:35:50	<b>2:35:50</b>
127.	40	LANCELLE, Julien	M	114	ATCC	62576M82	26:37	04:32	1:16:21	03:22	45:02	<b>2:35:54</b>
128.	220	VAN EYCKE, François	M	115	TRIGT	63554M96	26:57	04:11	1:14:13	03:08	47:28	<b>2:35:57</b>
129.	274	CARLIER, Jerome**	M	116			29:49	04:39	1:13:37	03:53	44:03	<b>2:36:01</b>
130.	67	DE KONINCK, Patrick	M	117	Brasschaat triathlon club	02622M63	28:00	03:50	1:12:58	03:18	48:16	<b>2:36:22</b>
131.	159	KARKAN, Alexandre	M	118	RCBT	59700M95	21:37	02:54	1:16:41	04:39	50:38	<b>2:36:29</b>
132.	299	BANSE, Nicolas	M	119			29:06	04:36	1:17:14	02:51	42:47	<b>2:36:34</b>
134.	97	CHARLET, Victor <i>HEPH C</i>	M	120	Endurance team Mouscron	65497M02	32:40	03:53	1:12:39	03:20	44:09	<b>2:36:41</b>
136.	196	LAMMENS, Thomas	M	121	TDW	26303M90	27:39	03:13	1:18:23	03:02	44:39	<b>2:36:56</b>
137.	14	VANDROMME, Pieter-Jan	M	122	3FT	33931M86	28:22	03:50	1:12:58	03:16	48:35	<b>2:37:01</b>
138.	118	DUFRANE, Gil	M	123	MADRES	56721M68	30:51	03:48	1:10:18	03:17	49:08	<b>2:37:22</b>
140.	227	DELVILLE, Maximilien	M	124	TTB	65586M73	29:49	04:48	1:12:54	03:25	46:34	<b>2:37:30</b>



# Triathlon de Seneffe 2024

## Classement général Distance Olympique

Pl.	Doss	Nom Prénom	Sx	Pl.S	Club	Licence	Nat.	T1	Vélo	T2	Course	Arrivée
141.	37	SIMOENS, Gaetan	M	125	ATCC	57424M65	30:55	04:16	1:12:05	03:16	47:02	<b>2:37:34</b>
142.	217	DEFFERNEZ, Gauthier	M	126	TriGt	62539M76	30:31	03:23	1:13:32	03:48	47:12	<b>2:38:26</b>
144.	151	HAYETTE, Christophe	M	127	RCBT	63985M84	34:30	03:30	1:11:49	03:20	46:36	<b>2:39:45</b>
146.	119	VALET, Olivier	M	128	Madres	56081M68	28:32	03:12	1:15:15	03:04	49:51	<b>2:39:54</b>
147.	276	BAIVERLIN, Vincent	M	129			27:30	04:57	1:17:21	03:52	46:32	<b>2:40:12</b>
148.	108	MORTIER, Julien <i>HE VINCI</i>	M	130	GTC	66491M02	29:41	03:35	1:14:40	03:30	48:48	<b>2:40:14</b>
149.	283	LEMAIRE, Quentin**	M	131			31:32	04:18	1:11:14	04:49	48:22	<b>2:40:15</b>
150.	228	DIEU, Nicolas	M	132	TTB	62651M74	32:10	03:37	1:14:55	02:59	46:49	<b>2:40:30</b>
151.	142	CURVERS, Lorenzo	M	133	PMX	64846M98	27:45	04:06	1:17:32	03:23	47:46	<b>2:40:32</b>
153.	261	WALRAVENS, Benoit	M	134			29:27	03:41	1:19:57	03:07	45:14	<b>2:41:26</b>
155.	303	DUVIVIER, Antoine**	M	135			30:02	03:02	1:14:52	03:29	50:31	<b>2:41:56</b>
156.	38	DELHAYE, Patrick*	M	136	ATCC	59265M67	30:07	04:41	1:13:21	03:27	50:21	<b>2:41:57</b>
157.	267	GASCON BURGADA, Carles	M	137			30:37	04:18	1:15:37	03:42	48:08	<b>2:42:22</b>
159.	193	CEUSTERS, Patrick	M	138	TDL	00240M65	29:55	04:11	1:15:44	03:47	48:59	<b>2:42:36</b>
160.	171	MANDERLIER, Maxime**	M	139	TCA	64209M85	32:29	03:48	1:15:28	03:28	47:37	<b>2:42:50</b>
162.	48	DEHOUX, Adrien <i>HELIAN</i>	M	140	AUCUN	/	35:32	03:23	1:15:23	03:38	45:23	<b>2:43:19</b>
165.	282	CHARLIER, Emilien**	M	141			29:21	05:14	1:12:26	05:07	52:06	<b>2:44:14</b>
167.	177	MAURISSEN, Hervé	M	142	TCBM	57102M66	26:39	04:08	1:17:06	03:51	53:45	<b>2:45:29</b>
169.	15	COOREVITS, Gert-Jan	M	143	3FT	120750M87			1:29:50		2:45:50	<b>2:45:50</b>
170.	264	NAZE, Cédric	M	144			28:23	04:13	1:16:58	04:03	52:21	<b>2:45:58</b>
171.	174	VERSTAEN, Cyril	M	145	TCA Triathlon Club andenne	65967M88	32:48	04:43	1:14:38	03:51	50:04	<b>2:46:04</b>
172.	49	LEVAUX, Louis <i>HE PL</i>	M	146	AUCUN	/	30:40	03:46	1:22:21	03:40	46:31	<b>2:46:58</b>
173.	224	VERSTICHEL, Thierry	M	147	TTB	62519M64	35:44	03:57	1:15:46	03:20	48:14	<b>2:47:01</b>
174.	29	VAN DEN NOORTGATE,	M	148	3T	57064M93	31:12	05:00	1:16:43	05:17	49:07	<b>2:47:19</b>
175.	180	VANBRABANT, Arnaud	M	149	TCBM	66569M90	33:16	03:46	1:18:45	03:52	47:46	<b>2:47:25</b>
176.	305	BARAS, Nathan	M	150			31:19	04:42	1:17:39	04:15	49:45	<b>2:47:40</b>
177.	39	BONFANTI, Thierry	M	151	ATCC	60354M81	29:19		1:44:50		2:48:15	<b>2:48:15</b>
178.	30	MUSCAS, Massimo	M	152	3T	64704M93	35:57	05:30	1:18:48	04:51	43:16	<b>2:48:22</b>
179.	257	GAETE DEL RIO, Nicolas	M	153		62743M77	33:14	05:56	1:12:58	04:25	52:06	<b>2:48:39</b>
180.	50	AGATONE, Hugo <i>UCL W</i>	M	154	AUCUN	/	29:59	04:52	1:21:42	04:06	48:14	<b>2:48:53</b>
181.	222	FLAS, Jérôme	M	155	TRILGE (Triathliège)	66481M94	29:39	04:07	1:12:47	03:09	59:23	<b>2:49:05</b>

# Triathlon de Seneffe 2024

## Classement général Distance Olympique

Pl.	Doss	Nom Prénom	Sx	Pl.S	Club	Licence	Nat.	T1	Vélo	T2	Course	Arrivée	
182.	253	PEETERS, Amaury	M	156				33:22	05:26	1:17:08	04:08	49:04	<b>2:49:08</b>
183.	249	VEKEMANS, Johan	M	157				29:00	04:23	1:21:06	04:17	50:49	<b>2:49:35</b>
184.	308	SCUFLAIRE, Emilien	M	158				26:58	04:28	1:21:49	06:13	50:22	<b>2:49:50</b>
185.	107	BENIN, Michel	M	159	Gtc	62193M66		29:29	04:15	1:19:02	04:01	53:15	<b>2:50:02</b>
186.	54	DOZIN, Gil <i>UCL W</i>	M	160	AUCUN	/		31:10	05:00	1:19:19	03:33	51:34	<b>2:50:36</b>
187.	225	BOUCHER, Richard	M	161	TTB	64815M65		34:31	03:32	1:17:59	03:30	51:24	<b>2:50:56</b>
188.	232	PETERS-DICKIE, Jean-Louis	M	162	TTB <i>Kulewen</i>	59027M97		27:18	03:45	1:18:04	04:13	57:44	<b>2:51:04</b>
190.	175	BOLLETTE, Bernard	M	163	TCBM	57859M59		31:37	04:46	1:21:14	03:41	50:24	<b>2:51:42</b>
191.	315	GUILMOT, Gabriel	M	164				30:33	05:04	1:24:13	03:41	48:32	<b>2:52:03</b>
192.	270	D'HALLEWIN, Alexandre	M	165				31:08	05:29	1:19:08	04:54	51:25	<b>2:52:04</b>
193.	176	FAFCHAMPS, Eudore	M	166	tcbm	64640M60		33:03	04:20	1:17:01	03:57	54:54	<b>2:53:15</b>
195.	275	MICHEL, Benjamin	M	167				30:20	04:53	1:20:51	05:18	52:15	<b>2:53:37</b>
196.	262	DE RIEMAECKER, Mathieu	M	168				35:49	05:23	1:17:19	04:00	51:21	<b>2:53:52</b>
197.	20	LHOST, David	M	169	3T	62792M70		32:00	04:46	1:23:06	04:09	50:17	<b>2:54:18</b>
198.	98	BILLAT, Arnaud	M	170	Escarabrow			34:21	04:02	1:16:10	04:11	55:41	<b>2:54:25</b>
199.	230	BEUDIN, Audric	M	171	TTB	63185M94		27:48	04:34	1:23:28	03:28	55:20	<b>2:54:38</b>
200.	298	CALLENS, Tom	M	172				31:30	04:46	1:19:19	04:16	54:48	<b>2:54:39</b>
202.	187	SOETE, Jeremy	M	173	TDA	65784M84		38:35		1:44:50		2:55:15	<b>2:55:15</b>
204.	206	YPERMAN, Michael	M	174	Triathlon The Very Bad Wolves			33:19	04:53	1:17:51	04:25	55:17	<b>2:55:45</b>
205.	251	MORTON, Timothy	M	175				33:26	07:04	1:22:34	04:41	48:33	<b>2:56:18</b>
206.	295	LAMBILOTTE, Arnaud	M	176				35:02	06:22	1:18:19	06:33	50:04	<b>2:56:20</b>
207.	291	FRANCOIS, Leopold	M	177				31:17	07:30	1:20:58	05:09	51:31	<b>2:56:25</b>
208.	92	VERSLYPE, Basile	M	178	Crossfitlink			30:12	04:54	1:24:47	03:25	53:15	<b>2:56:33</b>
211.	132	VANPOUCKE, Ludovic	M	179	OTT	59600M76		27:51	04:34	1:27:25	03:31	54:21	<b>2:57:42</b>
213.	266	HAYETTE, Damien	M	180				33:13	04:43	1:20:34	04:54	54:33	<b>2:57:57</b>
216.	11	BRAIBANT, Pascal	M	181	-	-		30:43	03:32	1:24:41	03:50	56:21	<b>2:59:07</b>
217.	143	CREFCOEUR, Philippe	M	182	RCBT	58616M64		31:07	04:21	1:22:31	03:18	57:53	<b>2:59:10</b>
218.	229	VANDENPLAS, Kevin**	M	183	TTB	66449M84		32:37	07:41	1:23:35	04:55	50:38	<b>2:59:26</b>
219.	70	ENGELS, Marc**	M	184	BTC	65458M63		35:48	05:23	1:21:57	04:58	51:47	<b>2:59:53</b>
220.	121	HENRIET, Alexandre	M	185	MADRES	66401M82		33:24	06:00	1:25:10	03:28	52:16	<b>3:00:18</b>
222.	294	DIEU, Francois-Xavier	M	186				34:00	04:49	1:20:54	06:19	54:24	<b>3:00:26</b>



# Triathlon de Seneffe 2024

## Classement général Distance Olympique

Pl.	Doss	Nom Prénom	Sx	Pl.S	Club	Licence	Nat.	T1	Vélo	T2	Course	Arrivée
224.	113	LIEGEOIS, Nicolas	M	187	Jett	62190M78	33:14	06:14	1:23:44	03:37	54:23	<b>3:01:12</b>
225.	21	FAUCON, Bruno	M	188	3T	66237M71	31:40	03:55	1:24:24	04:03	57:13	<b>3:01:15</b>
227.	28	PIROTTE, Yveric	M	189	3t	65609m91	31:24	04:47	1:23:22	04:22	58:02	<b>3:01:57</b>
229.	200	SERVAIS, Laurent	M	190	Tri M2R	64771m79	31:18	06:14	1:15:33	03:58	1:05:34	<b>3:02:37</b>
230.	269	LIEGEOIS, Thomas	M	191			38:55	05:35	1:24:14	03:35	50:20	<b>3:02:39</b>
232.	100	YUMUSAK, Alexandre	M	192	ETC (Endurance Team	62538M96	34:34	04:34	1:22:22	04:05	58:14	<b>3:03:49</b>
233.	57	SAGEHOMME, Julien <i>UCL W</i>	M	193	AUCUN	/	33:05	03:51	1:33:43	04:58	48:29	<b>3:04:06</b>
237.	32	COULON, Nathanael	M	194	3t	64392M96	37:07	06:18	1:29:45	04:34	50:44	<b>3:08:28</b>
238.	115	FRANCART, Olivier	M	195	LDLV	66619M75	34:28	05:48	1:27:39	05:58	54:39	<b>3:08:32</b>
240.	265	DE FAYS, Christophe	M	196			32:19	05:35	1:25:19	04:54	1:01:16	<b>3:09:23</b>
241.	120	DUQUESNE, Stéphane	M	197	Madres	65642M77	30:40	04:01	1:29:46	05:16	59:44	<b>3:09:27</b>
243.	259	DE BIE, Nicolas	M	198			33:20	07:00	1:24:16	04:08	1:01:15	<b>3:09:59</b>
244.	188	VANDEVENNE, Christian	M	199	TDCH	56453M53	38:41	06:29	1:23:18	04:27	57:39	<b>3:10:34</b>
245.	302	BENNARDO, Riccardo	M	200			33:42	05:39	1:34:58	03:40	52:40	<b>3:10:39</b>
247.	110	CALVAGNA, Franco	M	201	H3O	57621M62	33:06	06:12	1:19:51	05:22	1:06:19	<b>3:10:50</b>
248.	268	DU PARC, Gatien	M	202			35:53	07:11	1:24:36	04:52	58:27	<b>3:10:59</b>
250.	290	BOGAERT, Justin	M	203			36:12	06:23	1:31:13	04:17	55:07	<b>3:13:12</b>
252.	284	TOULMONDE, Antoine	M	204			33:37	09:28	1:28:22	04:56	59:16	<b>3:15:39</b>
256.	139	COLETTE, Thibaut	M	205	PDOTeam		31:15	05:01	1:26:53	05:00	1:12:57	<b>3:21:06</b>
257.	263	DELSAUT, Michael	M	206			39:53	07:57		2:14:36	1:07:07	<b>3:21:43</b>
258.	242	NUYTTEEN, Philippe	M	207	W.A.T.T	65933M72	39:30	08:00	1:28:34	06:36	59:25	<b>3:22:05</b>
260.	164	DUBOIS, Thibaut	M	208	RST Ath		43:55	09:18	1:33:36	05:21	52:55	<b>3:25:05</b>
262.	287	URBAING, Nicolas	M	209			34:10	05:52	1:33:55	05:16	1:07:33	<b>3:26:46</b>
263.	286	HIBEN, Kevin	M	210			39:32	08:24	1:35:53	06:38	57:43	<b>3:28:10</b>
264.	127	WALRAVENS, Jonathan	M	211	None		35:06	08:45		2:25:54	1:05:59	<b>3:31:53</b>
266.	95	MAAMER, Ryan	M	212	Detralytics		41:38	06:42	1:40:18	03:33	1:01:46	<b>3:33:57</b>
DSQ	2	GILLAIN, Michael	M	-1	Atcc	56515M93	21:35	03:03	1:02:19	02:18	37:12	<b>2:06:27</b>
DNF	172	THIRY, Sebastien	M	-1	TCA	64657M86	36:38	05:34				
DNF	301	PARIS, Mathieu	M	-1			34:05	06:23	1:15:10			

Nombre d'inscrits: 275

# Résultats du Championnat FSUB d'Ultimate Frisbee

KU Leuven

Mercredi 27 mars 2024



**KU LEUVEN**



## Speelschema BSK: Ultimate Frisbee

27/mrt/24

Locatie: Sportcampus Arenberg KU Leuven - Tervuursevest 101 - Heverlee



### Teams

KU Leuven  
AUGent  
UC Louvain

Timing	Wedstrijd		Uitslag
12u30	KU Leuven	AUGent	1-13
13u30	AUGent	UCLouvain	13-1
14u30	KU Leuven	UCLouvain	1-9
15u25	KU Leuven	AUGent	0-13
16u25	AUGent	UCLouvain	13-2
17u20	KU Leuven	UCLouvain	5-10

**Aanmelden:** Ingang Gebouw de Nayer om 11u30

**Wedstrijdduur:** 40 minuten of zodra een team 13 punten heeft

1 time-out (2min) per ploeg per wedstrijd toegelaten (niet in de laatste 5 min!)

FAIR - PLAY

7 tegen 7 met maximum 10-11 spelers per team

Vrouwen en mannen in 1 team zijn toegelaten

# FINALES FSUB

## FSUB Championship

Finales des championnats de Belgique de l'Enseignement Universitaire et Supérieur

### Tennis

Tennis KG1, KG2 KG3  
Dames > 10H00  
Hommes > 10H00

### Volley-ball

TSH U3  
Dames > 14H15  
Hommes > 18H15

### Basket-ball

TSH U1  
Dames > 13H00  
Hommes > 16H30

### Waterpolo

Piscine KU Leuven  
Mixte > 19H00

### Futsal

GDN  
Hommes > 12H30  
Dames > 15H00

### Football

KG1  
Hommes > 16H30

### Hockey

KHC  
Dames > 17H30  
Hommes > 19H00

### Handball

GDN  
Hommes > 17H30  
Dames > 19H30

### Rugby XV

Rugby Club Leuven  
Hommes > 15H00



**Mercredi 17 avril 2024**

**Sport Centrum KU Leuven (Arenberg)**

Topsportal Tervuursevest, 101- 3001 Heverlee

**Koninklijke Hockey Club Leuven (KHC)**

Hertogstraat 203 - 3001 Heverlee

**Koninklijke Stade Tennis club**

Kardinaal Mercierlaan 58 - 3001 Heverlee

**Rugby Club Leuven** - Koetsweg 204a-3010 Kessel-Lo

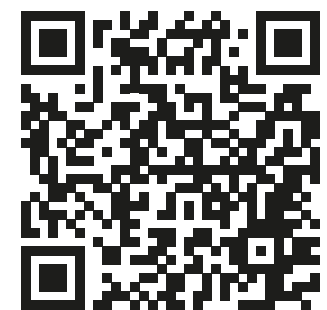

Scan le QR Code  
pour plus d'infos





**Résultats des Finales FSUB**  
**Leuven le 17 avril 2024**

BASKET-BALL DAMES	SCORE	VAINQUEUR
AUHA - ULiège (Liège)	67 - 61	AUHA
<b>BASKET-BALL HOMMES</b>		
Ass. KU Leuven - ULiège (Liège)	88 - 77	Ass. KU Leuven
<b>FOOTBALL</b>		
UAB - HENALLUX	0 - 2	HENALLUX
<b>FUTSAL DAMES</b>		
KU Leuven - UCLouvain Wolves	6 - 1	KU Leuven
<b>FUTSAL HOMMES</b>		
KU Leuven - UCLouvain Wolves	2 - 3	UCLouvain Wolves
<b>HANDBALL HOMMES</b>		
AUHL Limbucks – HE Vinci	25 - 28	HE Vinci
<b>HANDBALL DAMES</b>		
KU Leuven - HEPL	34 - 31	KU Leuven
<b>HOCKEY HOMMES</b>		
KU Leuven – ULB Owls	5 – 0 (Fft ULB)	KU Leuven
<b>HOCKEY DAMES</b>		
KU Leuven – UCLouvain Wolves	0 – 5 (Fft KULeuven)	UCLouvain Wolves
<b>RUGBY XV</b>		
KU Leuven – ULB Owls	0 - 34	ULB Owls
<b>TENNIS DAMES</b>		
UGENT – ULB Owls	0 - 3	ULB Owls
<b>TENNIS HOMMES</b>		
AUGent - UCLouvain Wolves 1	0 – 6 (Fft AUGent)	UCLouvain Wolves 1
<b>VOLLEY- BALL DAMES</b>		
Thomas More – ULiège (Liège)	3 – 1 (24/26-25/20-25/18- 26/24)	Thomas More
<b>VOLLEY- BALL HOMMES</b>		
UCLouvain Wolves – Ass. KU Leuven	2 – 3 (22/25- 25/20-25/21- 20/25- 15/13)	Ass. KU Leuven
<b>WATERPOLO</b>		
AUGent - HEPL/HENALLUX	5 – 0 (Fft HEPL/HENALLUX)	AUGent